

Coastal Zone  
Information  
Center

FOR DISPLAY ONLY

01030

**COASTAL ZONE  
INFORMATION CENTER**



**INTEGRITY  
OF THE  
CHESAPEAKE BAY**

*Maryland Chesapeake Bay Interagency Planning Committee*

HT  
392.5  
.C45  
M37  
1972

HON. MARVIN MANDEL  
*Governor of the State of Maryland*

*Maryland* CHESAPEAKE BAY INTERAGENCY PLAN-  
NING COMMITTEE ●

Vladimir A. Wahbe, *Chairman*  
*Secretary, Department of State Planning*  
James. B. Coulter, *Vice Chairman*  
*Secretary, Department of Natural Re-*  
*sources*  
Harry R. Hughes  
*Secretary, Department of Transportation*  
Howard E. Chaney  
*Director, Environmental Health Adminis-*  
*tration Department of Health and Men-*  
*tal Hygiene*  
Edmond F. Rovner  
*Secretary, Department of Economic and*  
*Community Development*

*\*Please see page 52 for special acknowledgements*

PROJECT COORDINATION

Robert F. Tribukait, P. E. . . . Roy G. Metzgar  
*Department of State Planning*

EX-OFFICIO REPRESENTATIVES

Dr. L. Eugene Cronin  
*Natural Resources Institute, University of*  
*Maryland*  
Dr. Donald W. Pritchard  
*Chesapeake Bay Institute, Johns Hopkins*  
*University*

STAFF ASSISTANCE

Albert R. Miller, *jr.*  
*Department of State Planning*  
John R. Capper, Christopher Slaughter  
*Department of Natural Resources*  
J. J. O'Donnell, Gary Smith  
Henry Douglas, Jerry White  
*Department of Transportation*  
W. McLean Bingley, Frederick Pyne  
*Department of Health and Mental Hy-*  
*giene*  
Dr. Robert M. Sparks  
*Department of Economic and Community*  
*Development*

SPECIAL ASSISTANCE

Specialized support was provided by the fol-  
lowing agencies:

Department of State Planning  
Department of Natural Resources  
State Highway Administration  
Maryland Port Administration  
Department of Economic and Community  
Development  
Regional Planning Council  
Maryland Soil Conservation Service  
Johns Hopkins University

This document was condensed by the Maryland Department of State Planning with assistance by Urban Research & Development Corporation from the Maryland Chesapeake Bay Study prepared by Wallace, McHarg, Roberts & Todd, Inc.

CONSULTANT

Urban Research & Development Corpora-  
tion, Bethlehem, Pennsylvania

2/  
INTEGRITY  
OF  
THE  
CHESAPEAKE  
BAY

U. S. DEPARTMENT OF COMMERCE NOAA  
COASTAL SERVICES CENTER  
2234 SOUTH HOBSON AVENUE  
CHARLESTON, SC 29405-2413

Property of CSC Library

The preparation of this Report, maps and documents were financed in part through a comprehensive planning grant from the Department of Housing and Urban Development, as administered by the Maryland Department of State Planning.

Comprehensive Planning Assistance Project  
No. Md. P-92

*This report is printed on reclaimed waste paper. Reclamation of paper is an example of how today's wastes can be re-used, easing the solid waste disposal crisis and preserving the quality of our environment.*

HT 392.5.C45 M37 1972  
67141  
MAY 13 1997



MARVIN MANDEL  
GOVERNOR

MARYLAND  
DEPARTMENT OF STATE PLANNING

301 WEST PRESTON STREET  
BALTIMORE, MARYLAND 21201  
TELEPHONE: 301-383-2481

VLADIMIR A. WAHBE  
SECRETARY OF STATE PLANNING  
NORMAN HEDDEN  
DEPUTY SECRETARY

The Honorable Marvin Mandel  
Governor of Maryland  
State House  
Annapolis, Maryland 21404

Dear Governor Mandel:

The Chesapeake Bay Interagency Planning Committee (CBIPC) was established at your request in 1969 to reflect the public concern for the immense economic, environmental and social values inherent in the Chesapeake Bay. The Committee was created to improve planning and management procedures between State agencies with Bay-related responsibilities. The Bay's natural resources must be studied comprehensively to minimize land and water-related impacts through the promulgation of policies for balanced use. Only through comprehensive management planning at the State level will Marylanders have continued enjoyment and utilization of the Chesapeake Bay's natural resources.

In 1970, CBIPC enlisted the services of the planning consultant firm of Wallace, McHarg, Roberts and Todd to study the Maryland portion of the Chesapeake Bay and to prepare a comprehensive inventory of the present and future Bay-related planning problems. Included in the technical document, which is under separate cover, are recommended goals, policies and management institutions which would respond most effectively to the Bay problems. This effort was initiated with the aid of a Comprehensive Planning Assistance Program grant by the Federal Department of Housing and Urban Development.

I am pleased to transmit the summary of the technical report entitled, "Integrity of the Chesapeake Bay" to you, to the General Assembly and to the citizens of Maryland for reaction. This report presents the technical documents contained in an abbreviated format which facilitates ease in comprehension and extensive distribution. The consultant's findings stress the necessary elements in defining a comprehensive Bay-wide plan and the mechanism for achieving this end. This report does not necessarily reflect a consensus of the Committee, but will be the primary input for further deliberations. Based upon CBIPC deliberations and statewide reaction, the Committee will soon be preparing a special report to you recommending the procedures for implementation of a Chesapeake Bay program.

This completed endeavor reflects a two-year effort and represents the first comprehensive Maryland Chesapeake Bay inventory of natural resources and economic development problems with suggested mechanisms for management planning.

Sincerely yours,

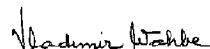
  
Vladimir A. Wahbe



<b>DESCRIPTION OF THE BAY</b>	5
<b>PROBLEMS AND GOALS</b>	9
WATER ENVIRONMENT OF THE ESTUARY	10
ENVIRONMENTAL QUALITY MANAGEMENT	15
FISH AND WILDLIFE	24
WATER SUPPLY	26
TRANSPORTATION	29
BAY ALTERATIONS	32
SHORELAND DEMANDS	35
SUMMARY OF PRESENT AND EMERGING PROBLEMS BY GEOGRAPHIC AREA	45
SUMMARY OF GOAL CONFLICT AND COMPATIBILITY	45
<b>THE NEXT STEP</b>	47
ELEMENTS OF A COMPREHENSIVE PLAN	48
INSTITUTIONAL ALTERNATIVES	48

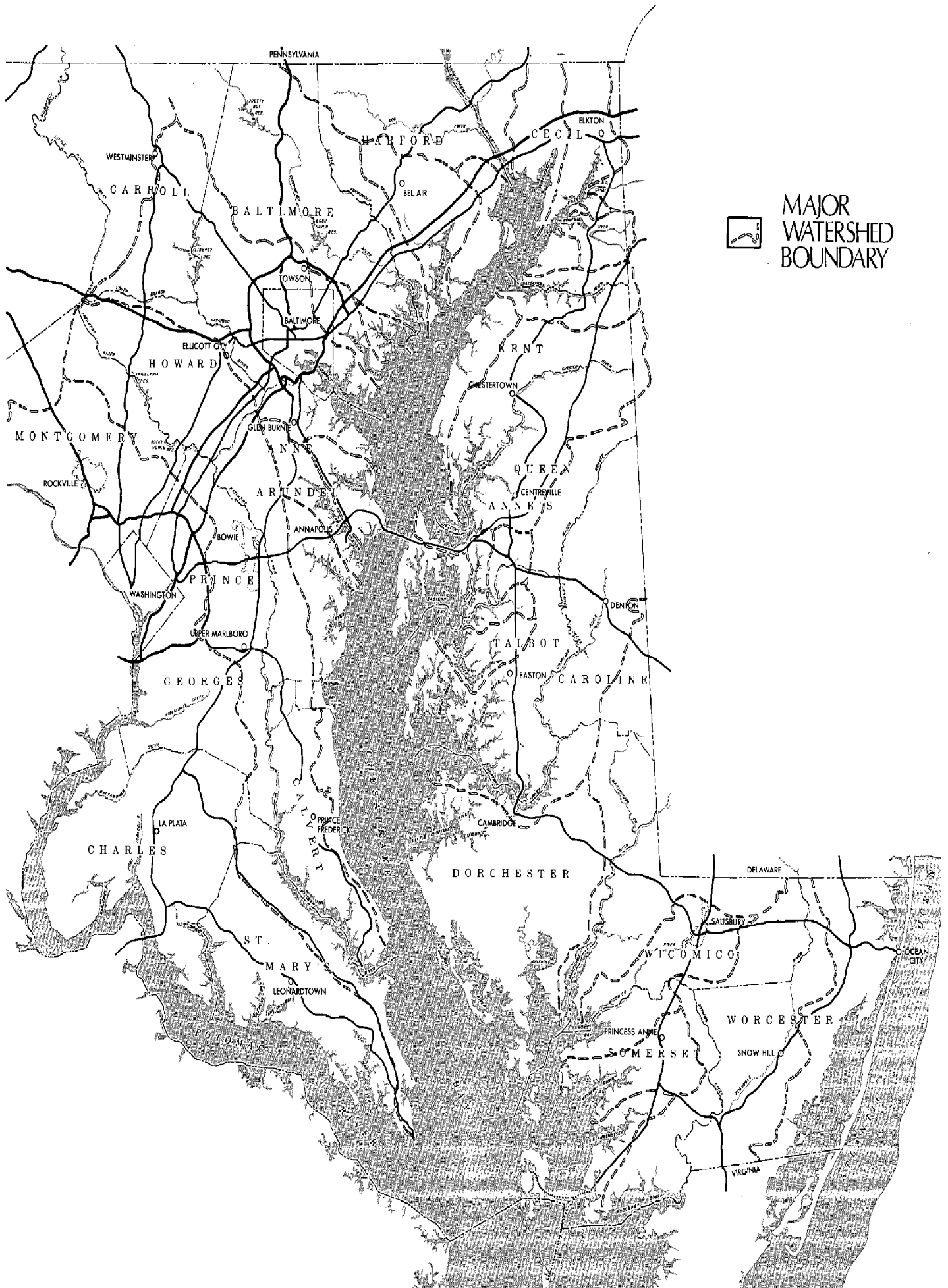

## DESCRIPTION OF THE BAY

## DESCRIPTION OF THE BAY

The Chesapeake Bay and its tributaries comprise one of the largest estuarial systems on earth. The Bay is approximately 200 miles in length and varies in width from four miles near Annapolis to about 30 miles near the mouth of the Potomac River. The tidal shore line comprises 3,400 miles in Maryland and 1,200 miles in Virginia.

The surface area of the Bay and its tributaries is approximately 4,400 square miles; the surface of the Bay itself is about 2,200 square miles. The Bay proper has a mean depth of less than 28 feet. The entire system, including tributaries to the head of tide, averages about 21 feet deep. There are, however, deep areas which occur as long, narrow troughs, thought to be remnants of the ancient Susquehanna River valley which have not been filled by sediments. The deepest trough (about 174 feet) occurs off Kent Island where the Bay is narrowest.

The Bay receives water from a basin of 64,170 square miles. Over 50 rivers with varying geochemical and hydrologic characteristics contribute fresh water to the Chesapeake Bay.

The mean tidal fluctuation in the Chesapeake Bay is one to two feet. Tidal currents range from 0.5 knots to over two knots.

Salt content ranges from 35 parts per thousand inside the mouth of the bay to near zero at the north end. Salinity in the bay decreases during winter and early spring, while salinity in the smaller tributaries is greater than in the bay during this period. Because of this significant difference in salt content, surface water from the bay flows into the tributaries, while bottom water from the tributaries flows into the bay. As bay salinity increases through summer and early fall, bay waters flow into the bottom of the tributaries, while tributary surface waters flow into the bay.

During the winter, the bay is high in dissolved oxygen content. With spring and higher water temperatures, the dissolved oxygen content decreases. Through the summer, lower layers (below 30 feet) become oxygen deficient. In early fall, the oxygen content at all depths begins to increase until distribution is almost uniform.

The physical and chemical dynamics of the estuary make it a biologically special place where both fresh water and salt water organisms can live. Fresh water animals and plants remain in the fresh or slightly brackish portions and many marine animals return to fresh water to reproduce. Also, currents carry the eggs and larval forms of some species to less salty water to hatch or develop.

The Chesapeake Bay, because of its long shoreline and extensive shallows, weed beds, and marshes, provides nourishment for young animal

TABLE 1 POPULATION CHANGE, 1960-1970, BY COUNTY

County and Region	1960 Population <sup>(a)</sup>	Net Population Increase (+) or Decrease (-) 1960 to 1970	1970 Population <sup>(a)</sup>
Anne Arundel Co.	206,600	+90,000	297,500
Baltimore City	939,000	-33,300	905,800
Baltimore Co.	492,400	+128,600	621,100
Carroll Co.	52,800	+16,300	69,100
Harford Co.	76,700	+38,700	115,400
Howard Co.	36,200	+25,800	61,900
Baltimore Region	1,803,700	+267,000	2,070,700
Montgomery Co.	340,900	+181,900	522,800
Prince George's Co.	357,400	+303,200	660,600
Washington Metro	698,300	+485,100	1,183,400
Calvert Co.	15,800	+4,900	20,700
Charles Co.	32,600	+15,100	47,700
St. Mary's Co.	38,900	+8,500	47,400
Southern Maryland	87,300	+28,400	115,700
Caroline Co.	19,500	+320	19,800
Dorchester Co.	29,700	-260	29,400
Kent Co.	15,500	+670	16,100
Queen Anne's Co.	16,600	+1,850	18,400
Somerset Co.	19,600	-700	18,900
Talbot Co.	21,600	+2,100	23,700
Wicomico Co.	49,100	+5,190	54,200
Worcester Co.	23,700	+710	24,400
Eastern Shore	195,200	+9,880	205,000
Cecil Co.	48,400	+4,880	53,300
Md. Chesapeake Bay Region	2,833,000	+795,200	3,628,200

a) Bureau of Census  
 Maryland Population and Housing Characteristics  
 Table 9 "Population and Land Area of Counties: 1960 & 1970" p. 22-15  
 (figures rounded to nearest 100)

forms and protects them from predators and rough water. The marshes of the Bay generate organic nutrients which are vital links in the animal food chain.

The Bay produces large crops of estuarine species. The most important economically are the soft-shelled clam, oysters, blue crabs, menhaden, and rock fish. Fish use the bay for many purposes. Many of the 238 recorded species are permanent residents. Shad and river herring spawn at the headwaters. Striped bass and white perch spawn in the nearly fresh water of the upper Bay, then the young spread throughout the Bay. Many ocean spawners use the Bay as a nursery. A wide variety of oceanic species enter the Bay to feed.

In recent years, the commercial seafood harvest from the Bay has exceeded one-half billion pounds annually, with an estimated annual value of more than \$65 million and employing nearly 20,000 persons. In addition, a significant number of game fish are landed by sport fishermen. Sport fishing and boating contribute to the tidewater way of life, cherished by residents and visitors.

Waterborne commerce, totaling 10 million tons a year, travels through the waterway and contributes to the economy of an 11-state area, extending into the Midwest. The trend in commercial navigation is toward larger ships which require deep channels, in turn posing problems in locating dredge-spoil disposal areas.

The population within the Maryland Chesapeake Bay Region was estimated to be 3.6 million in 1970.

The region is projected to increase at an average annual rate of about 1.5 percent through the year 2000 as noted on Tables 1 and 2. Table 3 depicts the employment growth patterns by industry and area in the Chesapeake Bay Region. The Bay area's population is supported by rich farmlands, vast woodlands and intensely developed industrial areas.

The rapid increases in population and in water-oriented pursuits have created conflicts among competing interests. The basin includes developed areas which sustain a vigorous economy and other areas where the economy is depressed as a result of technological changes. The development of resources is essential to both areas: for the first, to maintain and expand existing economic activity; and for the latter, to provide a base upon which new economic activities can grow. In depressed areas, new industries and improved recreation facilities are expected to be prime factors in economic development. Elsewhere in the Bay area, several of the major water-using industries are expected to grow and to create large, new demands for water of adequate quality.

TABLE 2 NET POPULATION GROWTH RATES, ACTUAL & EXPECTED, 1960-2000; BY DECADE, BY COUNTY

County and Region	1960 Actual <sup>a)</sup> Percentage	1970 Expected <sup>b)</sup> Percentage	1970-1980 Expected <sup>b)</sup> Percentage	1980-1990 Expected <sup>b)</sup> Percentage	1990-2000 Expected <sup>b)</sup> Percentage
Anne Arundel Co.	44.0	53.3	31.2	22.2	18.1
Baltimore City	-3.5	0.8	0.5	0.5	0.5
Baltimore Co.	26.1	31.0	24.4	15.4	13.4
Carroll Co.	30.7	26.0	13.1	25.1	20.1
Harford Co.	50.4	44.1	36.1	28.1	21.9
Howard Co.	71.3	80.5	72.9	45.3	31.2
Baltimore Region	14.8	19.2	16.6	13.3	11.7
Montgomery Co.	53.3	49.0	24.0	19.0	16.0
Prince George's Co.	84.8	73.8	24.0	15.1	13.1
Washington Metro	69.5	61.7	24.0	16.9	14.4
Calvert Co.	30.7	38.3	19.7	38.2	27.6
Charles Co.	46.4	30.9	36.5	14.7	12.8
St. Mary's Co.	21.8	30.3	19.6	9.4	8.6
Southern Maryland	32.6	32.0	25.9	16.7	14.0
Caroline Co.	1.6	5.7	0.1	12.1	10.8
Dorchester Co.	-0.9	3.2	4.9	19.3	16.2
Kent Co.	4.3	15.9	4.9	24.3	19.6
Queen Anne's Co.	11.2	10.4	6.6	11.5	10.3
Somerset Co.	-3.6	3.1	4.9	7.7	7.1
Talbot Co.	9.8	8.6	13.4	21.5	17.7
Wicomico Co.	10.6	14.1	4.5	14.1	12.4
Worcester Co.	3.0	6.8	0.5	19.3	16.2
Eastern Shore	5.0	8.5	4.6	16.2	14.0
Cecil Co.	10.1	22.2	22.4	14.6	12.7
Md. Chesapeake Bay Region	28.1	29.4	18.6	14.7	12.8

a) Bureau of Census

Maryland Population and Housing Characteristics

Table 9 "Population and Land Area of Counties, 1960 & 1970" p. 22-15 (figures rounded to nearest 100)

b) based on: "State of Maryland Population Projections, 1960-2000" (Ref. 13)

TABLE 3 EMPLOYMENT PROJECTIONS 1960-1980, BY SUBREGION AND RATES OF GROWTH, BY DECADE

		EMPLOYMENT (000)			PERCENT OF TOTAL EMPLOY. <sup>a)</sup>			RATES OF GROWTH	
		1960	1970	1980	1960	1970	1980	1960-1970	1970-1980
<b>BALTIMORE REGION</b>									
<b>INDUSTRY GROUPS</b>									
Agriculture	(SIC01-09)	17.0	12.7	12.4	2.4	1.6	1.4	25.2	-2.3
Mining	(SIC10-14)	1.2	1.2	1.6	0.2	0.2	0.2	0.0	33.3
Construction	(SIC15-17)	40.5	46.4	54.7	5.8	5.9	6.1	14.5	17.8
Manufacturing	(SIC19-39)	205.0	208.7	213.5	29.2	26.7	23.6	1.8	2.2
Transp. Communic. & Pub. Util.	(SIC40-49)	55.2	53.5	56.4	7.9	6.8	6.2	3.0	5.4
Wholesale Trade	(SIC50)	35.8	45.8	60.0	5.1	5.9	6.6	27.9	31.0
Retail Trade	(SIC52-59)	112.7	128.8	148.2	16.0	16.5	16.4	14.2	15.0
Finance, Ins., Real Estate	(SIC60-67)	36.7	43.8	52.1	5.2	5.6	5.8	19.0	18.9
Services	(SIC70-89)	131.0	165.0	215.7	18.6	21.1	23.9	25.9	30.7
Government <sup>b)</sup>	(SIC91-93)	67.3	76.7	89.1	9.6	9.8	9.9	13.9	16.1
Total		702.4	782.7	903.7	100.0	100.0	100.0	11.4	15.4
Population (000)									
Actual		1804	2071					14.8	
Expected			2151	2507				19.2	16.6
<b>DC METRO REGION (MD. PART)</b>									
<b>INDUSTRY GROUPS</b>									
Agriculture	(SIC01-09)	8.0	6.1	6.0	4.6	2.2	1.4	23.7	-1.6
Mining	(SIC10-14)	0.8	0.8	1.2	0.4	0.3	0.3	0.0	50.0
Construction	(SIC15-17)	16.6	30.3	48.3	9.5	10.7	11.5	82.5	59.4
Manufacturing	(SIC19-39)	10.1	14.1	16.2	5.8	5.0	3.9	39.6	14.8
Transp. Communic. & Pub. Util.	(SIC40-49)	4.9	7.8	11.2	2.8	2.7	2.7	59.1	43.5
Wholesale Trade	(SIC50)	2.9	9.2	15.2	1.7	3.3	3.6	217.2	65.2
Retail Trade	(SIC52-59)	34.6	66.5	93.3	19.9	23.4	22.3	92.1	40.3
Finance, Ins., Real Estate	(SIC60-67)	8.6	20.8	33.1	4.9	7.3	7.9	141.8	59.1
Services	(SIC70-89)	54.8	85.4	133.1	31.5	30.1	31.9	55.8	55.8
Government <sup>b)</sup>	(SIC91-93)	32.9	42.8	60.2	18.9	15.1	14.4	30.0	40.6
Total		174.1	283.9	418.3	100.0	100.0	100.0	63.0	47.3
Population (000)									
Actual		698	1183					69.5	
Expected			1129	1401				61.7	24.0
<b>SOUTHERN MARYLAND</b>									
<b>INDUSTRY GROUPS</b>									
Agriculture	(SIC01-09)	7.2	5.5	5.6	30.5	19.0	14.9	23.6	1.8
Mining	(SIC10-14)	0.0	0.0	0.0	0.0	0.0	0.0	0.0	58.3
Construction	(SIC15-17)	0.8	1.2	1.9	3.3	4.3	5.2	50.0	33.3
Manufacturing	(SIC19-39)	1.4	1.2	1.6	5.9	4.3	4.2	14.2	60.0
Transp. Communic. & Pub. Util.	(SIC40-49)	1.1	1.0	1.2	4.5	3.6	3.3	9.0	20.0
Wholesale Trade	(SIC50)	0.5	1.1	1.4	2.1	4.0	3.9	120.0	27.2
Retail Trade	(SIC52-59)	3.4	5.2	7.7	14.5	18.0	20.5	52.9	48.0
Finance, Ins., Real Estate	(SIC60-67)	0.7	0.8	1.0	3.0	2.8	2.7	14.2	25.0
Services	(SIC70-89)	4.9	7.2	10.1	20.8	24.9	27.0	46.9	40.2
Government <sup>b)</sup>	(SIC91-93)	3.6	5.6	6.9	15.5	19.3	18.5	55.5	23.2
Total		23.5	29.0	37.6	100.0	100.0	100.0	23.4	29.6
Population (000)									
Actual		87	116					32.6	
Expected			115	145				32.0	25.9
<b>EASTERN SHORE</b>									
<b>INDUSTRY GROUPS</b>									
Agriculture	(SIC01-09)	18.3	13.5	13.4	25.1	17.6	16.4	26.2	-0.7
Mining	(SIC10-14)	0.1	0.1	0.1	0.1	0.1	0.1	0.0	0.0
Construction	(SIC15-17)	2.7	4.0	4.5	3.7	5.2	5.6	48.1	12.5
Manufacturing	(SIC19-39)	18.6	19.1	18.1	25.6	24.8	22.2	2.6	-5.2
Transp. Communic. & Pub. Util.	(SIC40-49)	3.2	4.0	4.4	4.5	5.2	5.4	25.0	10.0
Wholesale Trade	(SIC50)	2.8		3.2	3.8	4.2	4.2	14.2	6.2
Retail Trade	(SIC52-59)	8.7	11.5	13.8	11.9	14.9	16.9	32.1	20.0
Finance, Ins., Real Estate	(SIC60-67)	1.9	2.6	2.8	2.6	3.4	3.4	36.8	7.6
Services	(SIC7089)	13.4	15.5	17.0	18.4	20.2	20.9	15.6	9.6
Government <sup>b)</sup>	(SIC91-93)	3.0	3.4	3.9	4.2	4.5	4.8	13.3	14.7
Total		72.8	76.9	81.5	100.0	100.0	100.0	5.6	5.9
Population (000)									
Actual		195	205					5.1	
Expected			212	222				8.5	4.6
<b>CECIL COUNTY</b>									
<b>INDUSTRY GROUPS</b>									
Agriculture	(SIC01-09)	2.0	1.5	1.4	14.1	9.5	7.9	25.0	-6.6

# PROBLEMS AND GOALS

**PROBLEMS & GOALS—WATER ENVIRONMENT OF THE ESTUARY**

**WATER MOVEMENT & SALINITY INTRUSION**

The Susquehanna River and Chesapeake Bay are parts of the same hydrologic system. The flows entering the mouth of the Bay from the Susquehanna constitute approximately 50 percent of all fresh water entering the Bay and 80 percent of fresh water entering the Bay above the Potomac River. Figure 1, Chesapeake Bay Water Budget, provides a representation of the total hydrologic system.

Flows from the Susquehanna River form a pool of fresh water in the upper Chesapeake Bay.<sup>1</sup> This fresh water is gradually "mixed" with saline water from the Atlantic Ocean. During the spring high flow period, a fresh water pool normally occurs in a zone from Spesutie Island to Turkey Point (Figure 2). Variations in Susquehanna River flows result in seasonal changes in the salt content of the upper Bay, as illustrated by Figure 3.

Water of three parts per thousand (ppt) salinity has occasionally reached the area of the Susquehanna Flats at the mouth of the Susquehanna River. In 1964, a dry year, saline water nearly reached the Havre de Grace water supply intake on the Susquehanna River. Salinity values observed near Turkey Point changed from 0.1 ppt to 6 ppt during 1964 (Figure 3).

Farther south, other fresh water sources, such as the Potomac, Patuxent, Choptank and Chester Rivers, have significant impacts on Chesapeake Bay salinity levels. Seasonal variations in river flows provide the environment to sustain important brackish water (fresh salt) ecological systems in the upper Bay.

The 17-mile Chesapeake and Delaware Canal built in 1829 and enlarged in 1938 and authorized for enlargement in 1954, links the Chesapeake Bay with the Delaware Bay. Figures 4 and 5 show the exchange relationships between fresh and brackish water in the Canal.

The significance of fresh water losses through the C & D Canal is seasonal. Water losses through the first canal enlargement are equal to approximately one percent of average March-April Susquehanna River inflows, but 27 percent of August-October 1-in-20 year low flows of the Susquehanna River.

<sup>1</sup>Water is classified as fresh or saline on the basis of total dissolved salt content. Fresh water ranges from 0 to 3.5 parts per thousand (ppt) and saline from 3.6 ppt upward.

**FIGURE 1 CHESAPEAKE BAY WATER BUDGET**

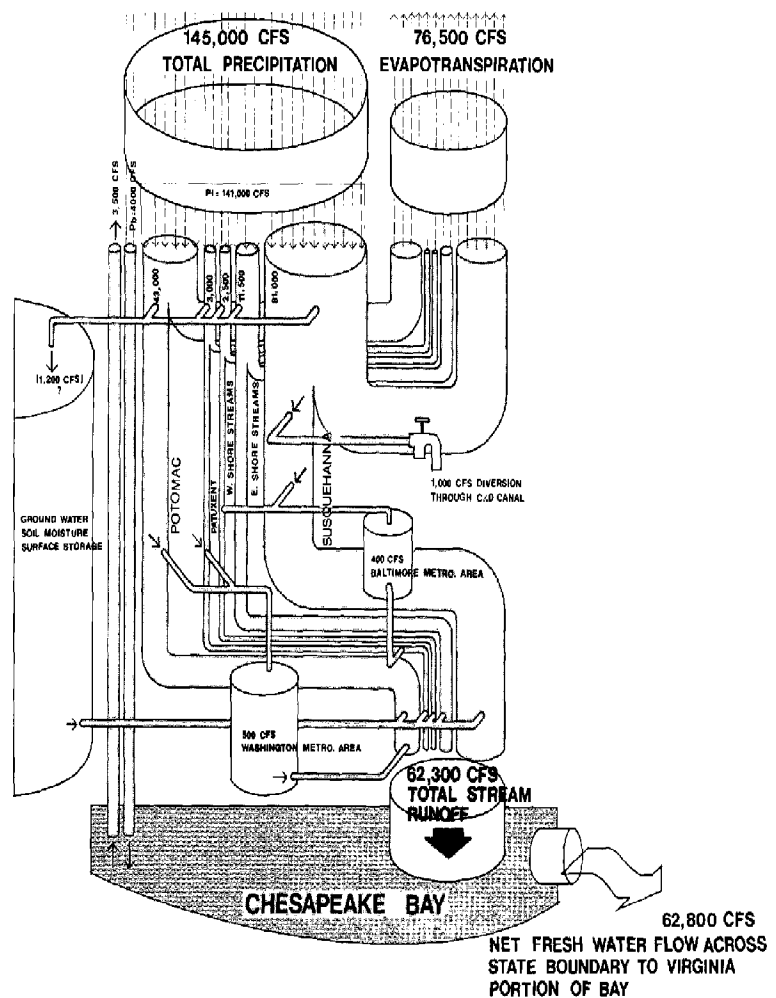



When the 1954 enlargement of the canal is completed, water losses will increase to approximately three percent of average March-April and 78 percent of August-October 1-in-20 year low flows of the Susquehanna River.

Projected consumptive uses of water in the Susquehanna River Basin will decrease the quantity of fresh water flowing into the upper Bay at any time of the year. The combined effect of decreased fresh water inflows and water loss through the C & D Canal will result in a northward shift of salt content in the Bay. Salinity of the upper Bay will increase most during low-flow months (Figure 6).

#### ECOLOGY OF THE UPPER CHESAPEAKE BAY

The impact of water exchange processes on the ecology of Chesapeake Bay must not be overlooked. The physical, chemical and biological patterns in the upper Chesapeake Bay depend on fresh water from the Susquehanna basin. The Susquehanna River is reported to be the principal

FIGURE 2 CHESAPEAKE BAY FRESH WATER FLOW (SPRING CONDITIONS)

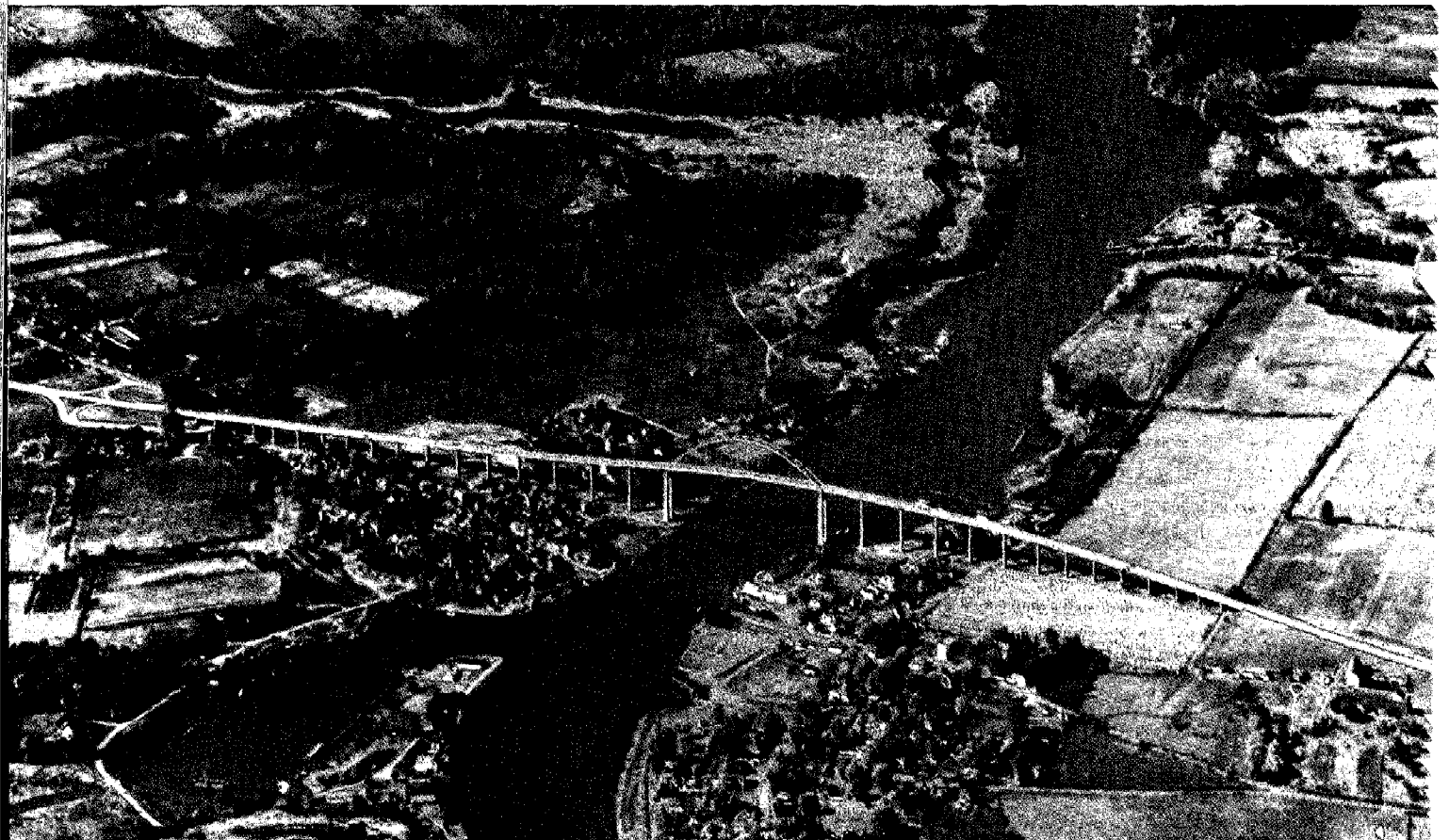
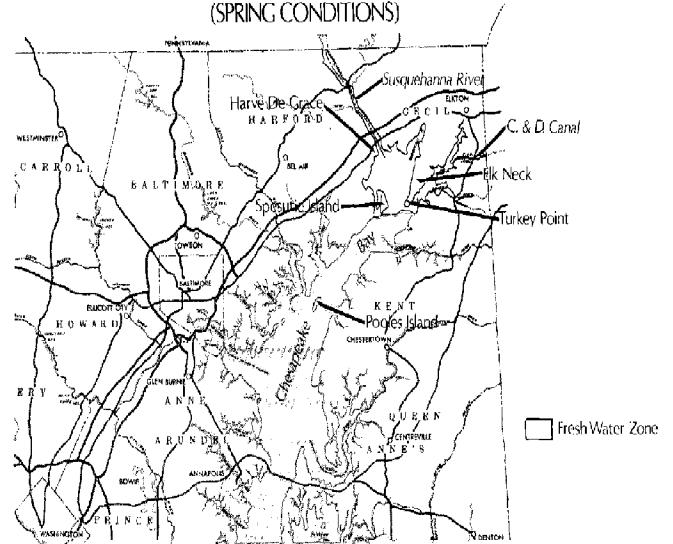
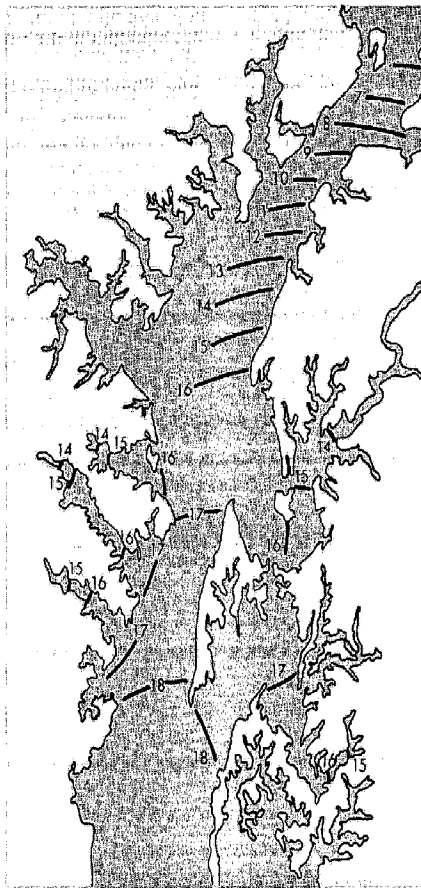

FIGURE 3A  
UPPER CHESAPEAKE BAY SALINITY  
(PPT) 24 APR.-1 MAY 1964



FIGURE 3B  
UPPER CHESAPEAKE BAY SALINITY  
(PPT) 9-13 NOV. 1964



*Effect of Susquehanna River discharges on surface salinity values in the spring (high flows) and fall (low flows) in 1964. Lines represent equal salinity observations in parts per thousand (p.p.t.).*

source of nutrient to the Bay, despite the contribution from Baltimore, other metropolitan areas, other tributaries and wetlands.

The ability of any body of water to assimilate nutrients is limited. Algal blooms have been observed in the upper Bay during the last few years. Beyond certain levels, the combined nutrient load from local waste discharges, natural production, and from waste discharges and land runoff in the Susquehanna basin could lower the oxygen level of the upper Bay and threaten the environment needed to support aquatic life in the Bay.

Plants are vital to all food chains. The predominant aquatic plant community in the upper Bay depends on fresh water. It is concentrated in an area known as the Susquehanna Flats where salinity values range from 0.1 parts per thousand (ppt) to 3 ppt, but rarely rise above 2 ppt. Most of the plant species can tolerate the higher salinities that occur during low-flow periods. This tolerance, however, is predicated on gradual increases in salinity and limited duration (3-4 months maximum) of high salinities, followed by recovery to fresh-water levels. Significant alteration of normal salinity fluctuations would eventually affect the composition and distribution of established fresh-water plant communities. Long-term replacement of fresh water by salt water (several successive years of higher salinity—5 ppt and above) would eliminate the fresh water aquatic plant communities established in the upper Bay.

Several species of fresh water plants are valued for waterfowl feeding. A national wildlife refuge has been established in the Susquehanna Flats to protect resting and feeding areas for migratory waterfowl which provide 25 to 50 million hunter-days per year.

Certain fishery resources of the Bay are intimately related to salinity regimens established in the upper Bay as a result of Susquehanna River

FIGURE 4 SALINE WATER MOVEMENT IN THE CHESAPEAKE & DELAWARE CANAL AND UPPER CHESAPEAKE BAY

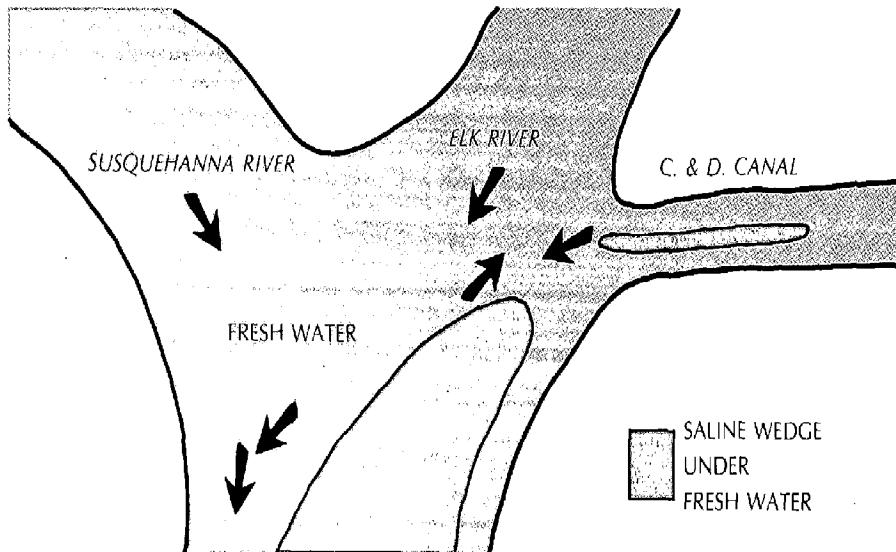
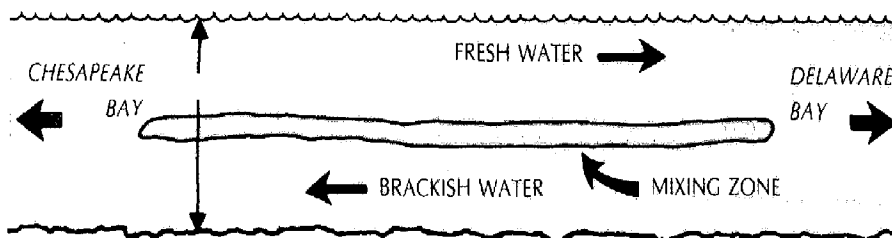

FIGURE 5 LONGITUDINAL CROSS-SECTION OF THE C. & D. CANAL SHOWING THE EXCHANGE RELATIONSHIPS BETWEEN FRESH & BRACKISH WATER THROUGH THE CANAL



flows. Rockfish or striped bass, for example, appear to spawn very near the interface between fresh water and slightly saline water. The flow regimen in the upper Bay may be essential to this species.

Other fish species such as the shad, herring, and white perch move into the upper Bay and tributary waters to spawn. They utilize the fresh water and low salinity areas of the Bay as nurseries for their young.

Species such as menhaden, weakfish or sea trout, spot, croaker or hardhead, harvest fish, winter flounder, and drum, spawn near the mouth of the Bay. Their eggs and larvae are carried toward the head of the Bay by the upstream drift of bottom water and reach the large crops of food in the productive low salinity areas. The upper Bay nursery ground for these species ranges from fresh water to a salinity of about 10 parts per thousand.

Salinity in the Bay, under the dominant influence of the Susquehanna, determines the upper limits of oyster bars and clam beds. The average upper limits are set by long-term flow patterns although exceptional high flows (floods) have destroyed large and important oyster beds. Lower flows and long-term higher salinity values would improve growth conditions and extend northward the habitat for oysters in the Bay. Overall, present knowledge indicates that existing oyster habitat is maintained by high spring and lower summer flows of fresh water into the upper Bay.

The distribution of the sea nettle is believed to be affected by salinity. Research indicates that they migrate up the Bay to salinities as low as 5 ppt. In general, this nuisance will probably retain its present distribution pattern because of the impact of low salinities resulting from spring high inflows of fresh water from the Susquehanna. However, any species that favor fall (higher) salinity values are apt to shift farther up the Bay if low flows are reduced or if more fresh water is diverted from the Susquehanna-Chesapeake Bay system.

FIGURE 6 C. & D. CANAL WATER LOSS FROM MARYLAND

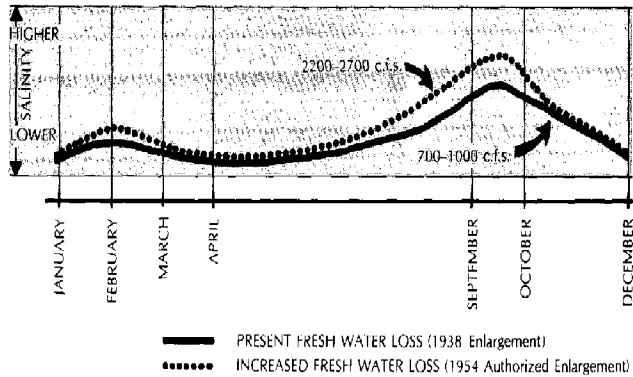
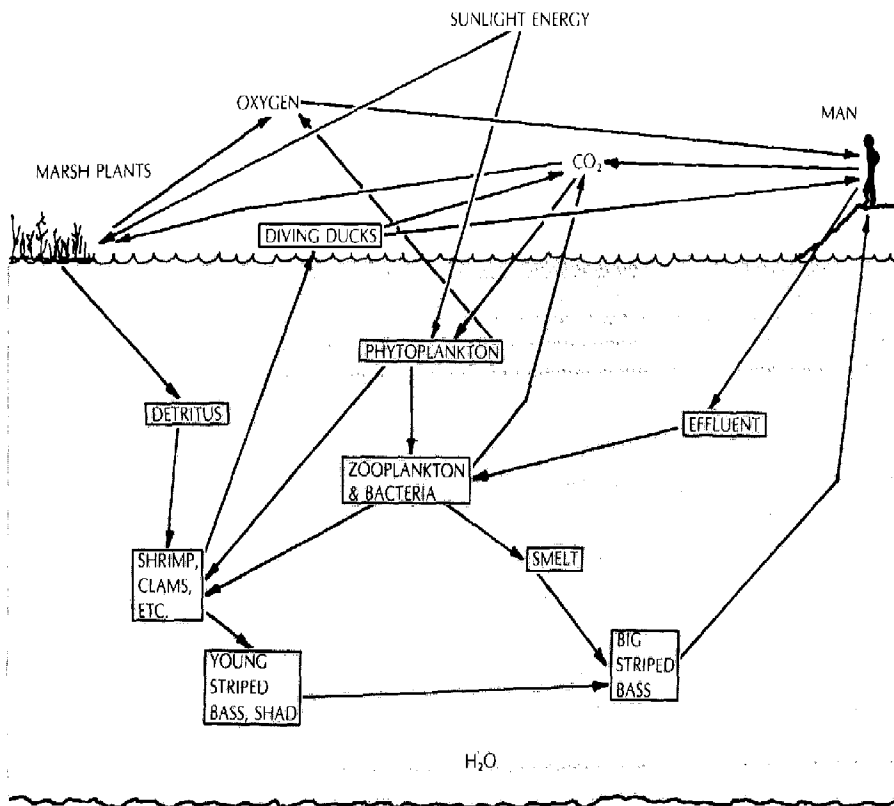

FIGURE 7 SIMPLIFIED BAY ECOSYSTEM



Man has already modified the productive environment of the upper Chesapeake Bay; and further modification is imminent. Uncertainty on the ecological effects of modification, however, hinders enlightened management, planning or policy decisions concerning Susquehanna River flows, Chesapeake and Delaware Canal diversions and upper Bay fresh-water requirements. Although knowledge is limited as to the effects of altering the Susquehanna River-Chesapeake Bay system, confident statements regarding river flows and Bay ecology include:

- 1) High, spring, fresh-water flows are essential for flushing the upper Bay and its tributaries, and for establishing the patterns for salinity gradients and circulation.
- 2) High, spring, fresh-water flows reduce the extent of environment suitable for some organisms while enlarging areas suitable for others.
- 3) Low flows in late summer and fall permit up-Bay penetration of several undesirable species.
- 4) Species respond in various ways to Susquehanna flows. Net effects are complex and cannot be predicted in detail.
- 5) General targets for management of Bay species include maintenance of established flow regimens, enhancement of low flows, maintenance of high spring flows, minimizing diversions or consumptive losses, prevention of excessive nutrient enrichment, and minimizing environmental and ecological changes.

FIGURE 8 GENERALIZED WATER QUALITY STANDARDS

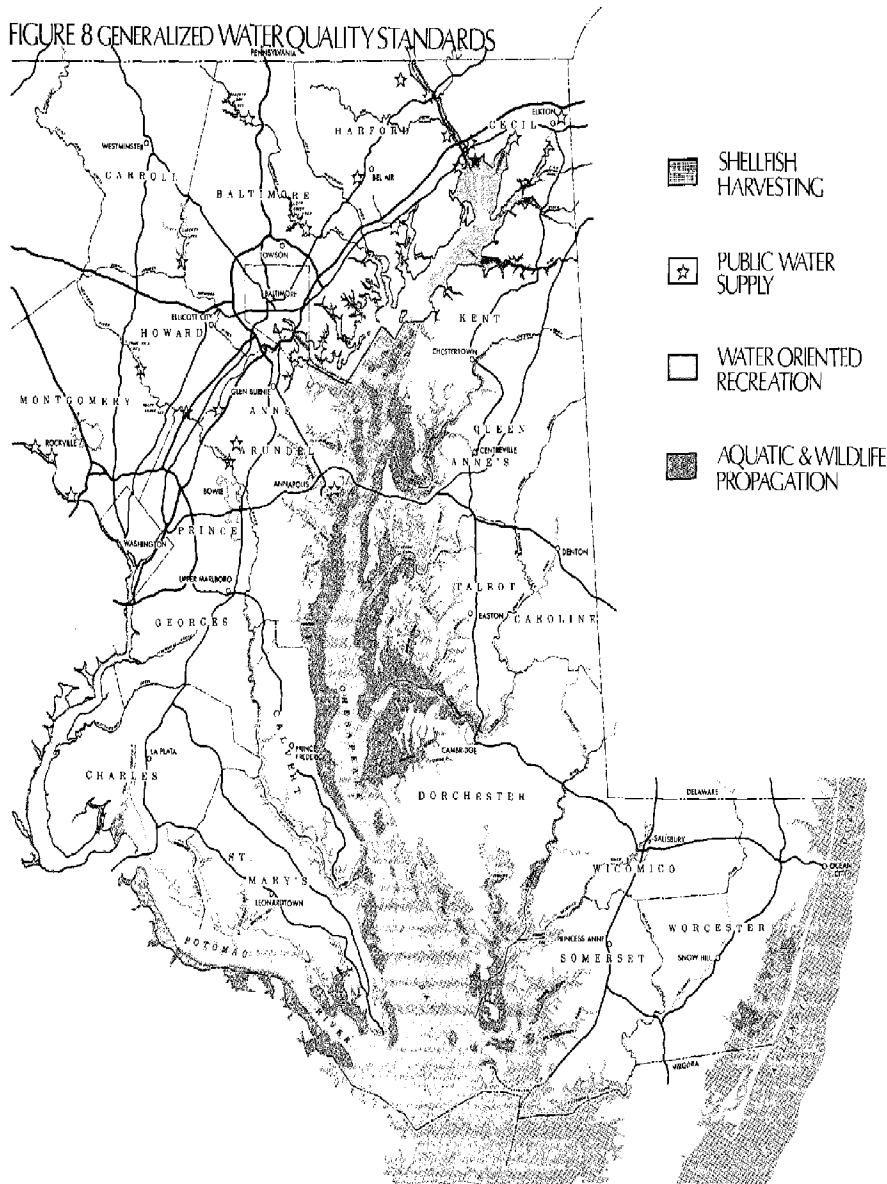

**PROBLEMS & GOALS—ENVIRONMENTAL QUALITY MANAGEMENT**

The problem is how to reconcile the need for liquid and solid waste disposal with the requirements of other Bay uses. Waste treatment and disposal might be considered optimal if the Bay's fish and wildlife resources are healthy and abundant, if recreational uses of the Bay such as boating and swimming are possible, and if the beauty of the Bay is unimpaired. The generalized water quality standards of the Chesapeake Bay are illustrated in Figure 8.

**DOMESTIC WASTES**

About 270 million gallons per day (mgd) of treated municipal sewage are discharged from Maryland counties into the Maryland portion of the Chesapeake Bay and its tributaries. Another 300 mgd are discharged into the Potomac estuary from Washington, D. C.'s Blue Plains Treatment Plant. Of the total of 570 mgd, about 5.4 mgd are discharged directly into the Bay.

Where municipal sewers are not available, State regulations require septic systems. The discharge of such systems is not included in the 570 mgd total, and it is not large by comparison, but it may cause local water pollution.

**INDUSTRIAL WASTES**

Industrial wastes vary from non-toxic rinse water or cooling water to extremely harmful chemicals, heavy metals, oil and grease. In some instances, such wastes are discharged into municipal sewer systems; but in many cases they are discharged directly, with or without treatment into the Bay and its tributaries.

**AGRICULTURAL WASTES**

The wastes from agricultural operations include animal excrement, pesticides, herbicides, and fertilizers. Both surface runoff and percolating ground waters carry these pollutants into the Bay.

Animal wastes and fertilizers are obnoxious to the senses, rob large quantities of oxygen from the water, contain disease-causing organisms, and accelerate the growth of aquatic plants. Pesticides and herbicides pose a critical threat to the health of the Bay ecosystem, especially its valuable fish and shellfish species.

Reliable estimates indicate that the magnitude of pollution caused by agricultural wastes is at least as great as that from municipal sewage, while treat-

ment of waters from farmland is not feasible due to its non-point nature.

Figure 9 (wastewater discharge) and Figure 10 (wastewater discharge diagram) show:

- 1) The total discharge of treated waste water by county;
- 2) The discharge, by county, of treated and raw wastewater into major watersheds; and
- 3) The total discharge received and carried by each major watershed.

Figure 11 (Major Sewage Treatment Plants) shows the location of sewage treatment plants with flows of 0.5 mgd or greater.

Allocations of liquid waste discharge by county

FIGURE 9 WASTEWATER DISCHARGE

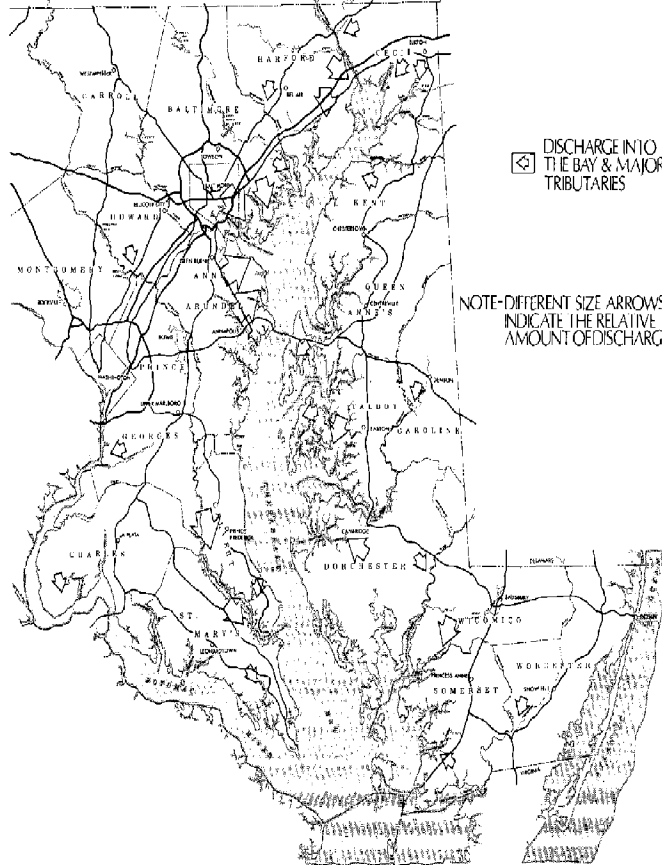
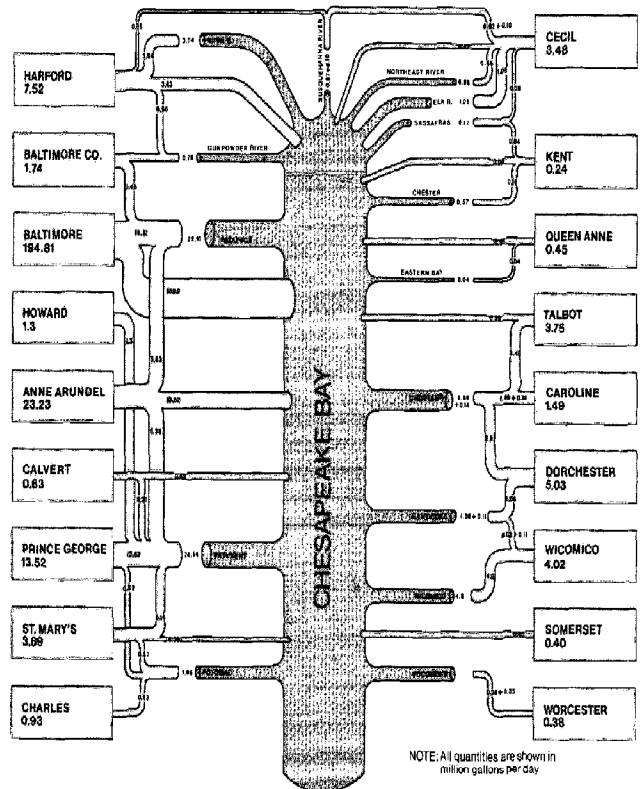

FIGURE 10 WASTEWATER DISCHARGE DIAGRAM



to major drainage areas (Table 4) are made on the basis of statistics developed by the Maryland Department of Health on the proportion of total wastewater flows of each county into major drainage areas. Table 5 presents an allocation of present and future liquid waste discharges to major watersheds feeding the Chesapeake Bay.

#### WATERCRAFT

The Chesapeake Bay accommodates many vessels, from large ships to small pleasure craft. It is estimated that raw sewage discharged into the Bay by vessels in transit is equivalent to that of a community of 20,000 people. In terms of its overall impact on the biological and chemical balance of

FIGURE 11 MAJOR SEWAGE TREATMENT PLANTS-FLOWS GREATER THAN 0.5 M.G.D.

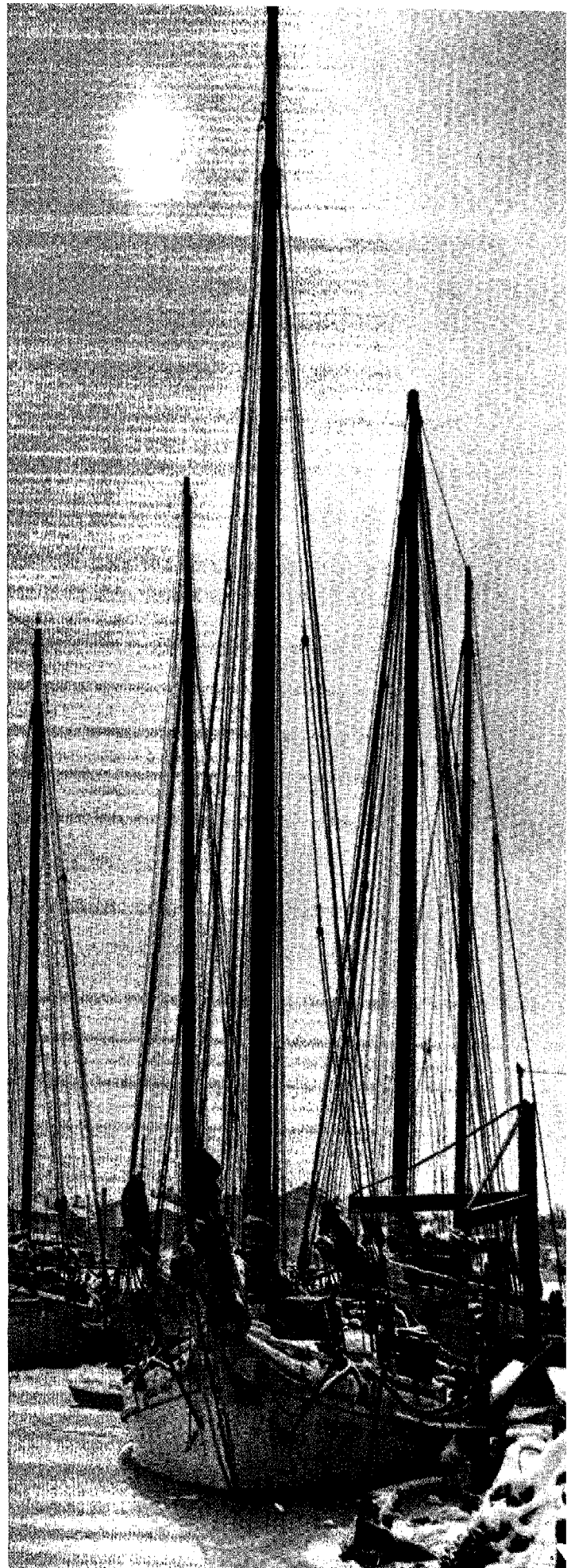
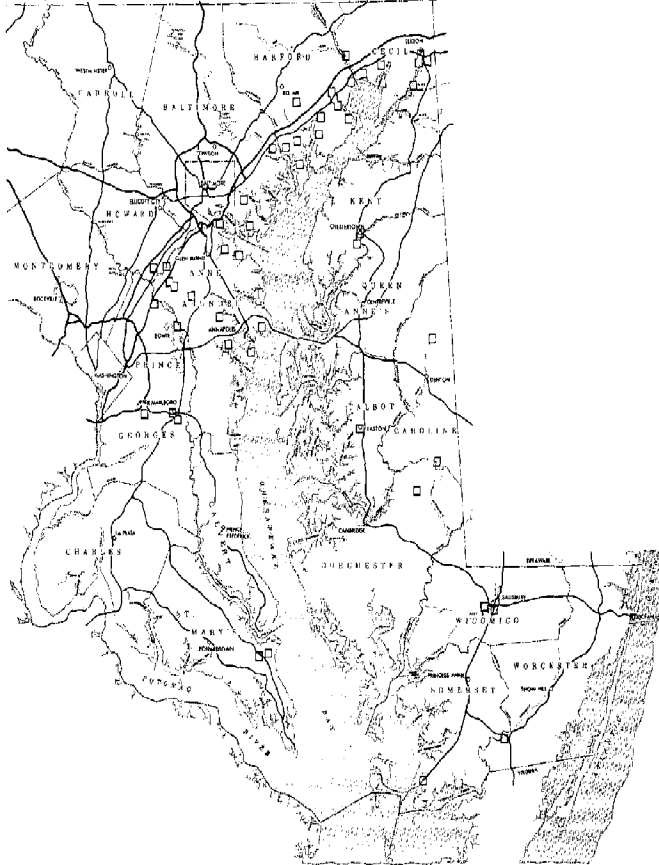

the Bay, this load is not too significant. But vessels congregate at marinas and anchorages; and if these areas are near bathing beaches or shellfish harvesting areas, serious health problems may result from the overboard disposal of sewage. An even more dreaded potential for pollution is the accidental spillage or deliberate discharge of large amounts of oil or other substances into the Bay.

If current practices in the treatment and discharge of wastes are allowed to continue, especially in conjunction with the increased use of water resources for recreation and industry, a general

downgrading of Bay water quality will result. Degradation would not be confined to the urbanizing western shore of the Bay, but would affect Eastern Shore areas as well, curtailing desirable uses of Bay water resources and shoreline areas.

Energetic and comprehensive use of water quality control and improvement techniques will ease some water pollution problems, namely a reduction in total BOD (Biological Oxygen Demand (Table 4). However, increasing concentrations of exotic chemical wastes in receiving waters and in synergistic relationships between different types of liquid

waste discharges will continue the decline of other areas.

A comprehensive application of traditional and creative approaches to water quality control could make possible the achievement of recommended water quality standards in the Bay and its tributaries. This approach would call for substantial increases in funding, monitoring, and organization for water quality control.

**Goal: Establish and Maintain Bay Water Quality at Levels Adequate for Living Resources and Human Enjoyment.**

TABLE 4: FUTURE DIMENSIONS OF LIQUID WASTE GENERATION AND DISCHARGE INTO BAY AND TRIBUTARIES, BY COUNTY

County	Population 1970	Liquid Waste Generation (lbs. BOD) @ .17 lbs. per capita per day	Estimated BOD Removal by Sewage Treatment <sup>1)</sup>	Estimated Liquid Waste (lbs.GOD) Discharge Into Bay or Tributaries	Population Projection 2000	Liquid Waste Genera- tion Range (lbs.BOD)		Estimated Liquid Waste Discharge Assuming:	
						@ .17 lbs. per capita per day	@ .20 lbs. per capita per day	1) increased rate of waste genera- tion (.20 lbs./ capita/day) and 2) present BOD removal	1) increased rate of waste generation (.17 lbs./ capita/day) 2) present BOD removal
						Anne Arundel	297,539	50,800	64
Baltimore City	905,759	154,000	83	25,900	960,700	163,300	192,100	32,700	16,300
Baltimore County	621,077	105,900	66	35,600	1,050,000	178,500	210,000	71,400	17,900
Carroll	69,006	11,800	(70)	2,700	113,000	19,200	22,600	6,800	1,900
Harford	115,378	19,600	73	5,200	235,000	40,000	47,000	12,700	4,000
Howard	61,911	10,500	90	1,000	215,000	36,600	43,000	4,300	3,700
Baltimore Metro	2,070,670	352,600		83,800	3,173,700	539,600	634,700	171,100	54,000
Montgomery	522,809	89,100	(70)	26,600	870,000	147,900	174,000	52,200	14,800
Prince George's	660,567	112,200	83	19,000	1,002,600	170,400	200,500	34,100	17,000
D. C. Metro	1,183,376	201,300		45,600	1,872,600	318,300	374,500	86,300	31,800
Calvert	20,682	3,500	(70)	1,000	46,200	7,900	9,200	2,770	790
Charles	47,678	8,100	(70)	2,400	75,300	12,800	15,100	4,520	1,280
St. Mary's	47,388	8,000	(70)	2,300	72,000	12,200	14,400	4,320	1,220
South Maryland	115,748	19,600		5,700	193,500	32,900	38,700	11,610	3,290
Cecil	53,291	9,100	92	710	93,600	15,900	18,700	1,500	1,590
Caroline	19,781	3,300	96	130	25,600	4,400	5,120	200	440
Dorchester	29,405	5,000	79	1,020	44,500	7,600	8,900	1,870	7660
Kent	16,146	2,700	94	160	28,000	4,800	5,600	340	480
Queen Anne's	18,422	3,100	(70)	890	24,000	4,100	4,800	1,440	410
Somerset	18,924	3,200	(70)	930	23,000	3,900	4,600	1,380	390
Talbot	23,682	4,000	67	1,240	38,000	6,500	7,600	2,510	650
Wicomico	54,236	9,200	79	1,890	75,000	12,800	15,000	3,150	1,280
Worcester	24,442	4,200	(70)	1,210	35,000	6,000	7,060	2,120	600
Eastern Shore	258,329	43,800		8,180	387,000	66,000	77,380	14,510	6,600
Md. Bay Region	3,628,123	617,300		143,280	5,626,800	956,800	1,125,280	283,520	95,680

Source: Maryland Department of Health



TABLE 5: FUTURE DIMENSIONS OF LIQUID WASTE DISCHARGES, BY MAJOR DRAINAGE AREA

Major Drainage Area	Liquid Wastes Discharged 1970 (lbs. BOD per day)	A. Liquid Wastes Discharged 2000 (lbs.BOD)	
		1) Increased Rate of Waste Generation	2) Present % of BOD Removal
Chesapeake Bay	34,190	59,310	22,890
Potomac R.	16,780	32,580	9,530
Patuxent R.	76,190	85,760	33,200
Patapsco R.	35,320	73,400	18,920
Gunpowder R.	6,680	13,880	3,570
Bush R.	2,440	5,970	1,880
Susquehanna R.	230	520	450
Northeast R.	130	270	290
Elk R.	210	450	480
Sassafras R.	40	90	110
Chester R.	920	1,530	690
Eastern Bay	80	130	40
Choptank R.	2,060	3,960	1,630
Nanticoke R.	270	490	200
Wicomico R.	1,830	3,060	1,240
Pocomoke R.	1,210	2,120	600
Total: Md. Bay Region	143,280	283,520	95,680

Source: Maryland Department of Health

### SOLID WASTE DISPOSAL

In the Chesapeake Bay Region, as elsewhere in the U. S., a growing urban population and economy are producing many kinds of solid wastes at increasing rates. "Solid wastes" are distinguished from liquid, thermal and other types of wastes by the manner and form in which they are collected and disposed.

Each available disposal method has a unique set of cost characteristics and side effects. Sanitary landfills involve the acquisition of land, which is expensive in urban areas. Efforts to find cheaper urban land have in the past led to the use of wetlands for sanitary landfills—and to disastrous ecological consequences. Sanitary landfill areas can be reclaimed for recreation or amenity reuse, but such plans for the future seldom mollify nearby residents who must live with the landfill operation in the meantime. Incineration of solid wastes requires major expenditures for capital facilities, and can contribute to air pollution.

Much solid waste does not lend itself to traditional disposal methods. Toxic industrial wastes are

not treated adequately by municipal sewage treatment plants while the residue from sewage treatment plants is generally unsuited for disposal in sanitary landfills.

The threat of solid waste disposal problems to the Chesapeake Bay results from the dwindling supply of space available for the disposal of solid waste (Tables 6, 7 and 8). Estimates indicate that by the year 2000, over 500 acres a year may be needed for solid waste disposal sites in the Maryland Bay Region (assuming landfills average 30 feet in depth). Most of the solid waste creating this space need would be generated in metropolitan areas where vacant land is scarce and expensive. As land costs in urban areas continue to rise, and as community opposition to proposed landfill sites becomes more intense, the Bay may become increasingly attractive as a site for solid waste disposal. In the Maryland Bay Region, the Bay has the added attraction of being close to metropolitan areas and requiring lower transportation costs than alternative disposal sites in the ocean or in non-metropolitan areas. The increasing amounts of toxic and non-degradable



Table 6: ANNUAL SOLID WASTE GENERATION OF 1960 POPULATION AND EMPLOYMENT

Existing Dimensions (Tons)	1960 Pop.	Solid Waste Generation Per Capita <sup>1</sup>	Solid Waste Generation
Baltimore Region	1,804,000	0.60 tons	1,090,000
Washington Metro Area	698,000	0.60 tons	420,000
Southern Maryland	111,000	0.60 tons	67,000
Eastern Shore			
Cecil County	244,000	0.60 tons	147,000
		Solid Waste Generation	Solid Waste Generation
Existing Dimensions 1960 Employ. Per Capita <sup>d</sup> (Tons)			
Baltimore Region	702,000	0.75 tons	528,000
Washington Metro Area	174,000	0.75 tons	131,000
Southern Maryland	23,000	0.75 tons	17,000
Eastern Shore	73,000	0.75 tons	55,000
Cecil County	14,000	0.75 tons	11,000
Existing Dimensions	Total Solid Waste Generation	Landfill Space Needs <sup>b</sup> @3.5 Cubic Yards/Tonk <sup>a</sup> (cu. yds.)	
Baltimore Region	1,618,000	5,650,000	
Washington Metro Area	551,000	1,931,000	
Southern Maryland	84,000	294,000	
Eastern Shore			
Cecil County	213,000	744,000	
TOTAL	2,466,000	8,619,000	

<sup>a</sup>Waste Management, Regional Plan Association, 1968, pg. 32; pg. 90-94. (On a per capita basis, the rate of solid waste generation is about 5 lbs. per day.)

<sup>b</sup>Assumes no incineration, recycling.

materials will compound the environmental effects of solid wastes disposed of at Bay sites.

**Goal: Establish Comprehensive Policies for Solid Waste Disposal Based Upon Economic, Social and Environmental Considerations.**

**THERMAL WASTE DISCHARGES**

A major concern in the economic growth of the Chesapeake Bay Region is how to meet increasing electrical energy requirements for a growing population. The Bay is a major potential source of cooling water for the discharge of waste heat; but higher water temperatures may harm fish and other aquatic life. Other by-products of the process of generating electricity also have potential for causing negative effects on shoreland uses.

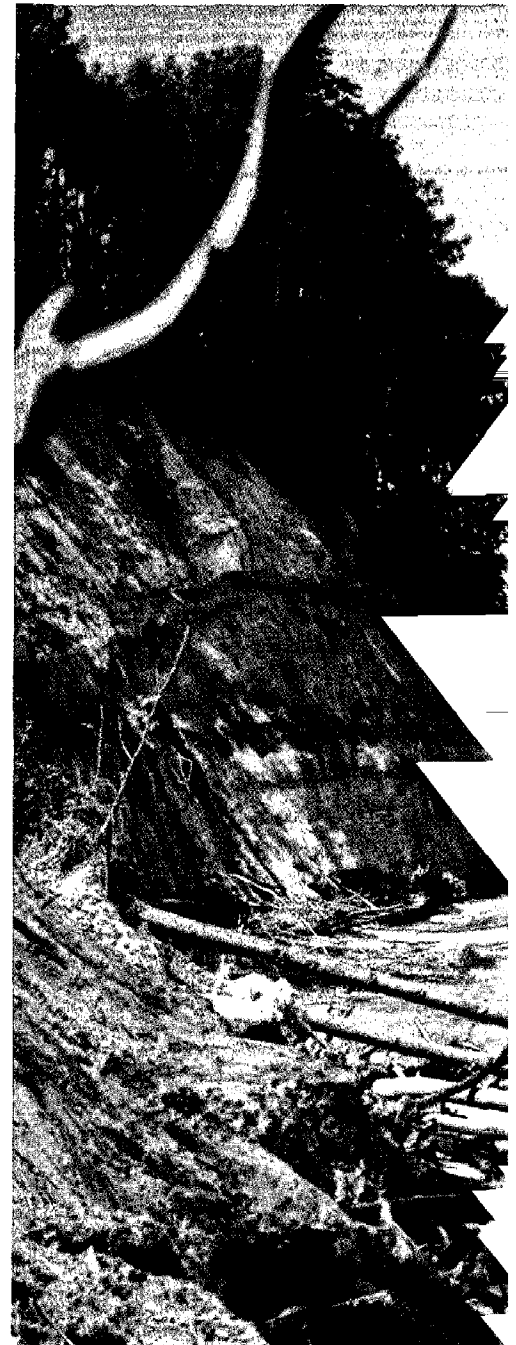

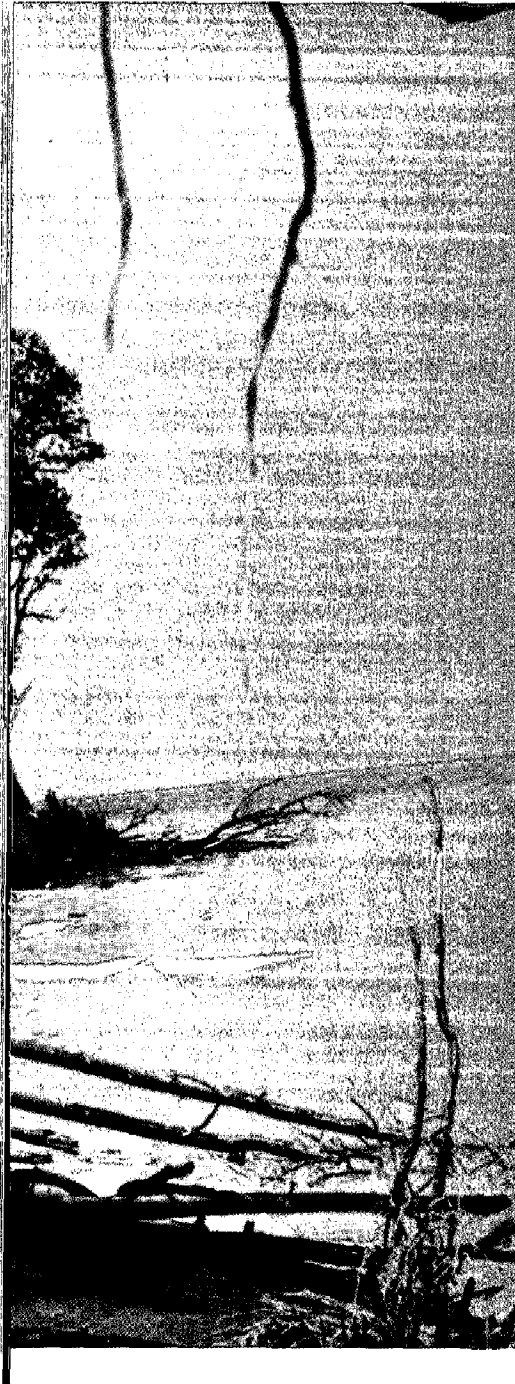

Nuclear power plants can be designed to minimize thermal pollution of the Bay by a variety of devices. However, all those currently envisioned would raise the cost of generating power.

Under present electricity transmission technology, the Western Shore of the Chesapeake Bay will be the scene of most future issues on the siting of electric power plants. The sub-estuaries leading into the Bay have limited capacity to supply cooling waters to large modern nuclear power plants.

Between 1960 and 1970, Maryland's population grew by 25 percent, and it is expected to continue to increase—though at declining percentage rates—in each remaining decade of the 20th Century. The population of Maryland in the year 2000 is expected to be over 1.5 times as large as in 1970.

More significant than population growth alone, the per capita and per family rates of electricity consumption are increasing. In 1940, the average

Table 7: ANNUAL SOLID WASTE GENERATION OF FUTURE POPULATION AND EMPLOYMENT: ASSUMES THAT EFFECTIVE POLICY MEASURES ARE EMPLOYED TO MAINTAIN THE RATES OF SOLID WASTE GENERATION CLOSE TO PRESENT LEVELS

Projections Current Rates	2000 Pop.	Solid Waste Generation Per Capita <sup>a</sup>	Solid Waste Generation (Tons)
Baltimore Region	3,457,000	0.60 tons	2,080,000
Washington Metro Area	1,974,000	0.60 tons	1,190,000
Southern Maryland	220,000	0.60 tons	132,000
Eastern Shore			
Cecil County	408,000	0.60 tons	246,000
Projections Current Rates	1980 Employ.	Solid Waste Generation Per Capita <sup>a</sup>	Solid Waste Generation (Tons)
Baltimore Region	904,000	0.75 tons	678,000
Washington Metro Area	418,000	0.75 tons	314,000
Southern Maryland	38,000	0.75 tons	29,000
Eastern Shore	82,000	0.75 tons	62,000
Cecil County	18,000	0.75 tons	14,000
Projections Current Rates	Total Solid Waste Generation	Landfill Space Needs <sup>b</sup> @3.5 Cubic Yards/Ton <sup>a</sup> (cu. yds.)	
Baltimore Region	2,758,000	9,630,000	
Washington Metro Area	1,504,000	5,260,000	
Southern Maryland	161,000	562,000	
Eastern Shore			
Cecil County	322,000	1,130,000	
TOTAL	4,745,000	16,582,000 92%	

<sup>a</sup>Waste Management, Regional Plan Association, 1968, pg 32; pg. 90-94

<sup>b</sup>Assumes no incineration, recycling.

Table 8: ANNUAL SOLID WASTE GENERATION OF FUTURE POPULATION AND EMPLOYMENT: ASSUMES THAT RATES OR SOLID WASTE GENERATION CONTINUE TO INCREASE ACCORDING TO CURRENT TRENDS

Projections, Trends	2000 Pop.	Solid Waste Generation Per Capita <sup>a</sup>	Solid Waste Generation (Tons)
Baltimore Region	3,457,000	1.15 tons	3,960,000
Washington Metro Area	1,974,000	1.15 tons	2,270,000
Southern Maryland	220,000	1.15 tons	252,000
Eastern Shore			
Cecil County	408,000	1.15 tons	468,000
Projections, Trends	1980 Employ.	Solid Waste Generation Per Capita	Solid Waste Generation (Tons)
Baltimore Region	904,000	1.50 tons	1,360,000
Washington Metro Area	418,000	1.50 tons	625,000
Southern Maryland	38,000	1.50 tons	57,000
Eastern Shore	82,000	1.50 tons	123,000
Cecil County	18,000	1.50 tons	27,000
Projections, Trends	Total Solid Waste Generation	Landfill Space Needs <sup>b</sup> @3.5 Cubic Yards/Ton <sup>a</sup> (cu. yds.)	
Baltimore Region	5,320,000	10,650,000	
Washington Metro Area	2,895,000	10,170,000	
Southern Maryland	309,000	1,820,000	
Eastern Shore			
Cecil County	618,000	2,160,000	
TOTAL	9,142,000	24,800,000 (187%)	

<sup>a</sup>Waste Management, Regional Plan Association, 1968, pg 32; pg 90-94. On a per capita basis the rate of solid waste generation is about 8½ lbs. per day

<sup>b</sup>Assumes no incineration, recycling.

TABLE 9: RATES OF INCREASE IN COMMERCIAL ELECTRIC SALES IN MARYLAND: 1965-1969<sup>a</sup>

Sales <sup>a</sup>	COMMERCIAL		INDUSTRIAL			TOTAL (COMM. & INDUS.)		
	Annual <sup>a</sup> Increase	% Increase	Sales <sup>a</sup>	Annual <sup>a</sup> Increase	% Increase	Sales <sup>a</sup>	Annual <sup>a</sup> Increase	% Increase
1969 5,107			7,954	727	10.1%	13,061	1,205	10.2%
1968 4,629	478	10.3%	7,227	525	7.8%	11,856	1,032	9.5%
1967 4,122	507	12.3%	6,702	564	9.2%	10,824	972	9.9%
1966 3,714	408	11.0%	6,138	705	13.0%	9,852	1,128	12.9%
1965 3,291	423	12.9%	5,433			8,724		
Average Annual Percentage Increase 1965-1969		11.4%			10.0%			10.4%

Source: Maryland Statistical Abstract, State of Maryland, Department of Economic Development 1970, pg 176-77

<sup>a</sup>Million of kilowatt-hours

home consumed about 1,000 kilowatt-hours of electricity; today the average home consumption of electricity exceeds 5,400 kilowatt-hours. In Maryland, per capita commercial electricity consumption in 1960 was 488 kilowatt-hours; in 1970 the rate was 1,470 kilowatt-hours per capita—three times the 1960 rate. Commercial electric sales in Maryland (not adjusted for population growth) increased at an average annual rate of 11.4 percent between 1965 and 1969 (Table 9). Even if the future rate of increase in electricity consumption is one-half the average annual rate in these four years, consumption in the year 2000 will be over 3,600 kilowatt-hours per person—2.5 times the 1970 rate and 7.5 times the 1960 rate (Table 10).

Industrial electricity consumption in Maryland almost doubled in the 1960–70 decade. The average annual rate of increase in the years 1965–69 was 10 percent (Table 9). Even if the future annual rate of increase in industrial electricity consumption is one-half the 1965–69 average, industrial electricity consumption in Maryland is likely to double by 1980, and double again by the year 2000 (Table 10).

Given current relationships between installed capacity for generating electricity, electric power production, and electricity consumption, seven power plants of the size of the new Calvert Cliffs Nuclear Plant would be necessary to meet additional demands in 1980; and 73 1,600,000 kilowatt plants would be needed to meet additional demands in the year 2000. Since population projections indicate that over 80 percent of the State's population will continue to concentrate in the Baltimore and Washington metropolitan areas, it is likely that most of the thermal waste discharge from additional power plants would impinge directly or indirectly upon the Bay.

**Goal: Accommodate Thermal Waste Discharge Needs Through Comprehensive Analysis of Alternative Locations and Consideration of Economic, Social and Environmental Impacts**

TABLE 10: PROJECTED ELECTRICITY CONSUMPTION IN MARYLAND 1960–2000<sup>a</sup>

	1960	1970	1980			2000	
			No Per Capita Consump. Inc.	½ 1965–69 Rate of Inc.	1965–69 Rate of Inc.	No Per Capita Consump. Inc.	½ 1965–69 Rate of Inc.
<i>Commercial Electricity Consumption</i>							
Population in Millions (Projected)	3,101	3,875	(4,679)	(4,679)	(4,679)	(6,070)	(6,070)
Per Capita Electricity Consumption in KWHR	488	1,470	1,470	2,140 <sup>b</sup>	3,640 <sup>b</sup>	1,470	3,640 <sup>b</sup>
Electricity Consumption (Millions of KWHR)	1,517	5,699 <sup>a</sup>	6,890	10,046	17,079	8,940	31,024
<i>Industrial Electricity Consumption</i>							
Mfg. Employment (Projected)	264,250	(278,290)	(288,450)	(288,450)	(288,450)		
Elec. Consumption per Mfg. Emp. (KWHR)	15,600	28,600	28,600	47,000 <sup>b</sup>	78,500 <sup>b</sup>		
Elec. Consumption (Millions of KWHR)	4,114	7,954 <sup>a</sup>	8,260	13,600	22,693		36,095
<i>Total Electricity Consumption</i>							
Total Electricity Consumption in Md. (Millions of KWHR)	5,631	13,653	15,150	23,646	39,772		67,119
					38,686 <sup>c</sup>		62,872 <sup>c</sup>

<sup>a</sup>Projected on basis of 1965–69 average annual rate of increase.

<sup>b</sup>Derived from electricity consumption and population projections.

<sup>c</sup>Projected on basis of total commercial and industrial electric sales.

**PROBLEMS & GOALS—FISH AND WILDLIFE**

The living resources of the Chesapeake Bay benefit the human population of the Bay region. The problem is to maintain and enhance these benefits, which include: a large source of high-quality food with potential for increased productivity; recreational opportunities for fishing, hunting and bird-watching; a source of income to the commercial harvestors and processors of fish and shellfish; economic gain to those who provide facilities that service commercial and recreational users; scientific knowledge about the complex ecology of Bay life and about the biology of individual species; a unique educational resource for the citizens of the region; and a healthful, pleasing environment.

Environmental disturbances can destroy fish and shellfish habitats and disrupt life cycles. Natural hazards include storms, floods, extreme variations in salinity, limited nutrient supply, sedimentation, predators and parasites. Man-made impacts include the destruction of habitats by diking and filling wetlands, dredging and dumping of spoil, diversion of fresh water inflows to the Bay, accelerated sedimentation from agriculture and urban development and domestic and industrial pollution of the Bay, particularly of prime shellfish habitats (Figures 12, 13, 14).

In addition to the consumer, the parties most affected by the living resources problem are those who harvest and process fish and shellfish, including sport-fishermen. Also affected are those who supply and service the harvestors, such as boatyard and marina operators, tackle manufacturers and retailers, as well as Bay fisheries scientists and managers.

**FIGURE 12 AQUATIC HABITATS**

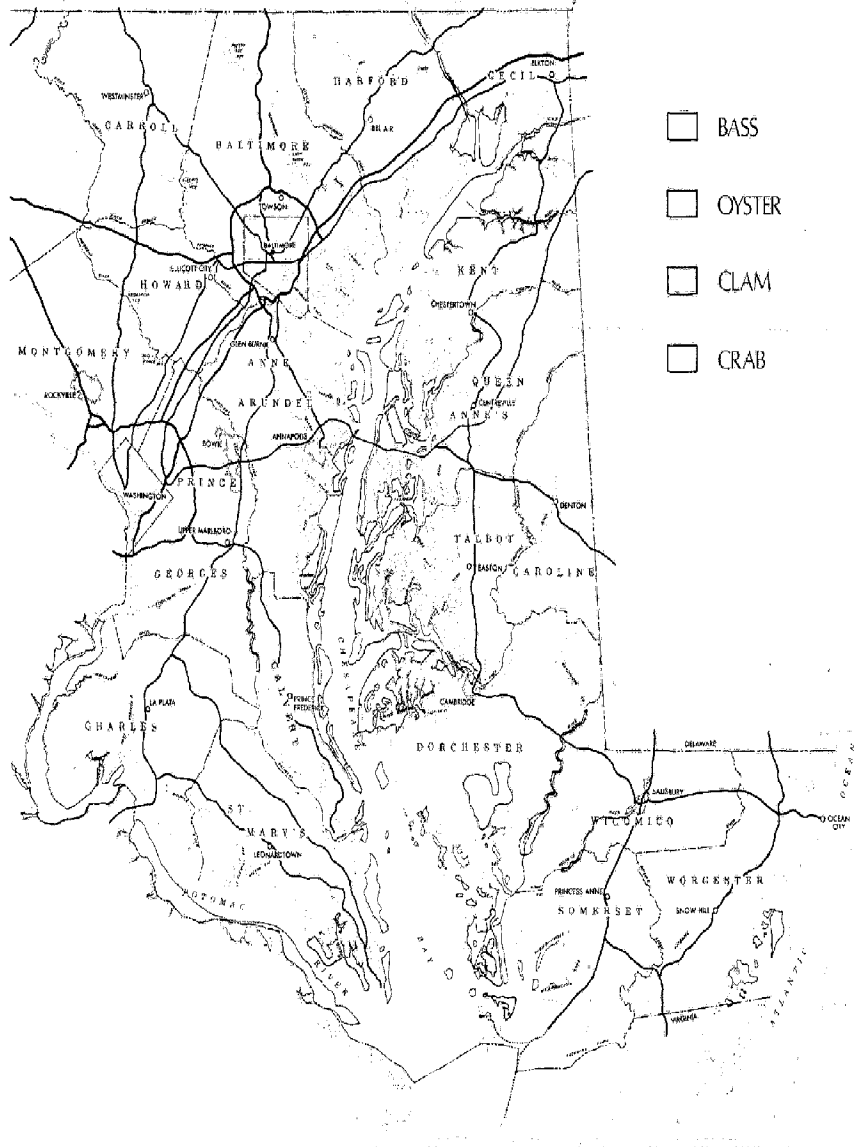

**TABLE 11. PRINCIPAL KINDS OF COMMERCIAL FISH AND SHELLFISH IN MARYLAND LANDINGS IN 1967, BY WEIGHT AND ESTIMATED VALUE, AND THEIR RANKINGS**

Rank by Wt.	Kind of Fish or Shellfish	Wt. in Millions of lbs.	Estimated Landed Value in Millions of Dollars	Rank by Value
1	Blue Crabs	26.791	2.448	2
2	Oysters	16.568	11.191	1
3	Clams	5.394	1.770	3
4	Menhaden	4.134	0.077	8
5	Striped Bass	4.072	0.665	4
6	Alewives	2.327	0.039	9
7	Swellfish	1.727	0.034	10
8	White Perch	1.199	0.168	5
9	Shad	0.884	0.091	7
10	Flounders	0.619	0.142	6
Subtotals		63.715	16.625	
GRAND TOTAL		79.946	16.913	

Source: Ref. 3

Current trends indicate gradually decreasing yields of fish and shellfish for commercial and recreational purposes (Tables 11 and 12). Contributing to these long-term trends are the depletion of aquatic resources through environmental degradation, and institutional constraints on the capacity of commercial and recreational fishing interests to pursue enlightened techniques for the management of the Bay's living resources:

**Goal: Maintain Large, Diverse and Healthy Populations of the Bay's Living Resources.**

TABLE 12. ESTIMATED SPORTFISHING CATCHES IN MARYLAND BY WEIGHT & VALUE

Kind of Fish or Shellfish	Wt. in Millions of Lbs.	Estimated Landed Value in Millions of Dollars (at Commercial Market Value)
Blue Crabs	26.8	2.45
Clams	2.7	0.9
Striped Bass	8.14	1.330
Alewives	1.16	0.02
Swellfish	0.86	0.017
White Perch	1.2	0.17
Shad	0.88	0.09
Flouders	0.62	0.14
<b>TOTAL</b>	<b>42.36</b>	<b>5.117</b>



FIGURE 13 CLAM & OYSTER HABITATS

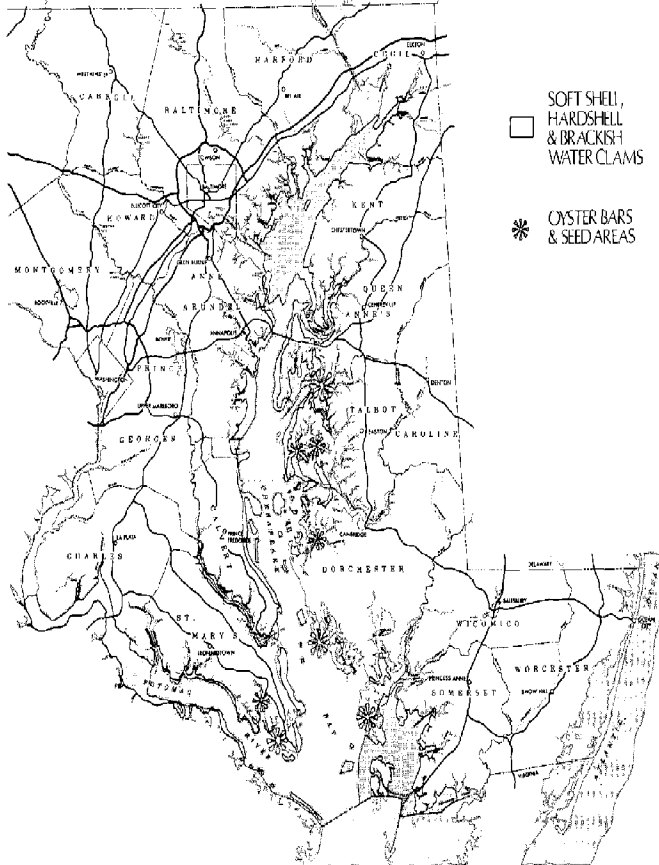

FIGURE 14 STRIPED BASS HABITATS

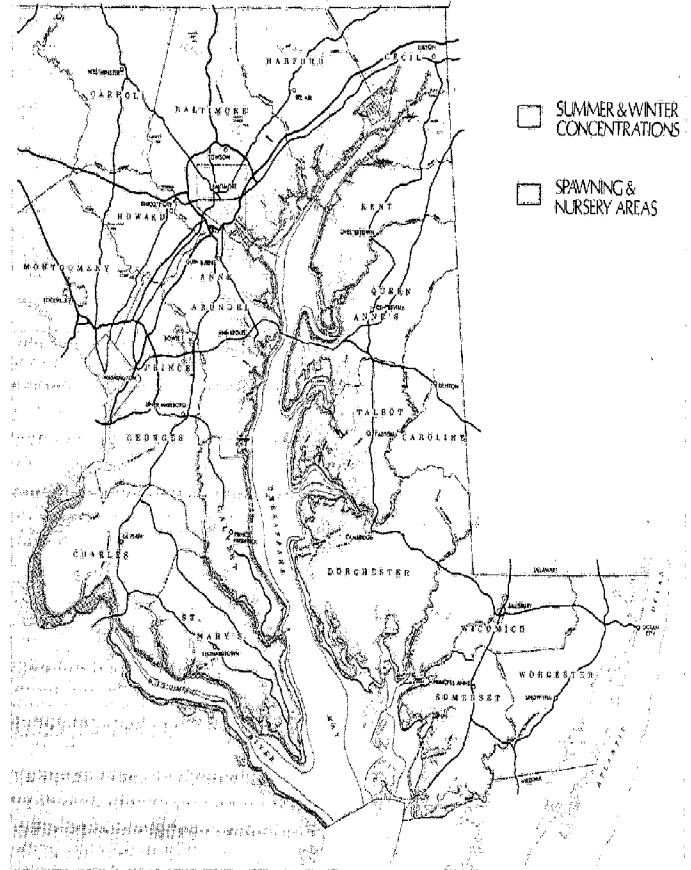
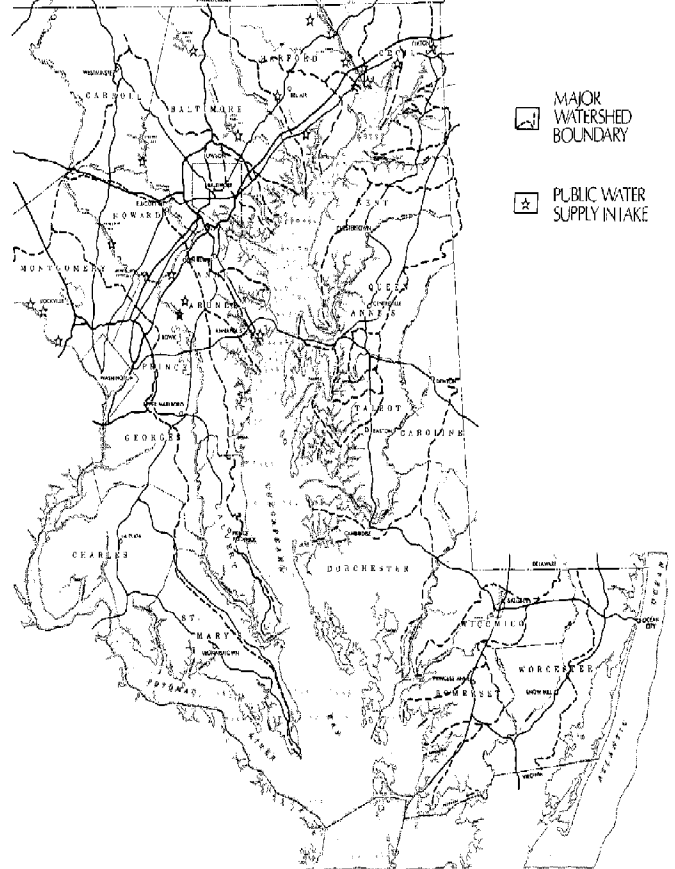

FIGURE 15 SURFACE DRAINAGE PATTERN & PUBLIC WATER SUPPLY INTAKES



**PROBLEMS & GOALS—WATER SUPPLY**

Maryland's water needs are increasing rapidly due to a growing population, the concentration of people in urban areas, and the expansion of water-using industries. To accommodate the demand for potable water supplies, Maryland must examine all possible alternatives for their environmental, economic and social effects. Wise planning and decision-making which recognizes the Chesapeake Bay as a portion of a total resource system can insure effective, practical solutions.

Figure 15 locates major public surface water intakes, while Table 13 aggregates these data for major streams and indicates the amount of water withdrawn per day and the population served. This information does not, of course, indicate the total water usage in any watershed, jurisdiction or group

TABLE 13: MAJOR PUBLIC SURFACE WATER SUPPLY INTAKES  
(DOES NOT INCLUDE GROUND WATER & INDUSTRIAL WATER SUPPLIES)  
(Source: Red. 1, Plate W, Table W-1).

POTOMAC	PATUXENT	LITTLE PATUXENT	CURTIS CREEK	SEVERN RIVER	PATAPSCO	GUNPOWDER
<sup>a</sup> Rockville (186A) 3.4 mgd 45,000 pop.	<sup>a</sup> Wash. Suburban San. Comm. (249B) 67 mgd 325,000 pop.	Maryland House of Correction (34A) 1.0 mgd 4,500 pop.	<sup>b</sup> Curtis Creek Coast Guard 0.6 mgd 7 pop.	<sup>b</sup> Severn River Naval Command 0.4 mgd 7 pop.	<sup>c</sup> Balt. City (48A) Ashburton Plant Liberty-Patapsco 56 mgd (approx) 375,000 pop. (app)	<sup>c</sup> Balt. City (48B) Pretty Boy-GNPDR 56 mgd (approx) 375,000 pop. (app)
<sup>a</sup> Wash. Suburban San. Comm. (249A) 150 mgd 725,000 pop.	<sup>a</sup> Wash. Suburban San. Comm. (249C) 67 mgd 325,000 pop.	<sup>b</sup> Ft. George Meade (27) 3.0 mgd 7 pop.				<sup>c</sup> Balt. City (48C) Montebello Plant Lock Raven-GNPDR 56 mgd (approx) 375,000 pop. (app)
Washington, D.C. (250) 200 mgd 1,093,000 pop.	Bowie Race Track (190) (Used during racing season only)					
353 mgd 1,863,000 pop.	134 <sup>+</sup> mgd 650,000 <sup>+</sup> pop.	4.0 mgd 4,500 <sup>+</sup> pop.	0.6 mgd 7 pop.	0.4 mgd 7 pop.	56 mgd 375,000 pop.	112 mgd 750,000 pop.



of jurisdictions. Ground water supplies, run-of-the river surface water intakes, and water transported across watershed and jurisdictional boundaries may supplement total public surface water intakes.

The surface drainage pattern is interjurisdictional. Of the 12 major watershed areas feeding the Maryland portion of the Chesapeake Bay, not one lies within a single jurisdiction. Ten of the twelve are interstate—six include portions of Delaware, three include portions of Pennsylvania, and two include portions of Virginia. Maryland's two interstate watersheds contain six and seven counties each. Most of the interstate watersheds also overlap three or more counties.

Before the year 2000, many urbanized counties will reach the limits of natural water supply systems

(Table 14). In these circumstances, it appears that urbanizing areas of the Maryland Bay Region will soon begin to be faced with difficult choices among alternative policy directions.

1) Regulate domestic per capita water demands and strongly encourage industry to economize on water use in production processes.

2) Undergo the major expense of meeting projected water demands by means of conventional water supply systems.

3) Develop more comprehensive approaches to the management of natural ground and surface water systems and exploit new sources of water supply.

**Goal: Provide an Adequate Water Supply for All Needs**

WINTERS RUN	BROAD CREEK	SUSQUEHANNA	MILL CREEK	NORTHEAST RIVER	BIG ELK CREEK
Bel Air (159A) 1.0 mgd 7,000 pop.	Broad Creek (162) (Summer Use only) 0.4 mgd 7 pop.	<sup>c</sup> Balt. City (48D) Susq. Diversion 56 mgd (approx) 375,000 pop. (app)	Perryville (99) 0.45 mgd 7 pop.	Northeast (98) 0.15 mgd 1,700 pop.	Elkton (91) 1.10 mgd 5,600 pop.
<sup>b</sup> Edgewood Arsenal (158A) 4.0 mgd 7 pop.		Conowingo (163A) 0.02 mgd 7 pop.	0.45 mgd 7 pop.	0.15 mgd 1,700 pop.	1.10 mgd 5,600 pop.
		Havre de Grace (167) 2.50 mgd 9,000 pop.			
		Bainbridge (86A) 1.50 mgd 7 pop.			
		Perry Point (100) 0.05 mgd 700 pop.			
5.0 mgd 7,000 <sup>+</sup> pop.	0.4 mgd 7 pop.	60.1 mgd 385,000 <sup>+</sup> pop.			

<sup>a</sup>Washington Suburban - 287 mgd; 1,420,000 pop. 1,178,000 (1970) pop. @ 80 gal/person/day

<sup>b</sup>Military - 8.0 mgd

<sup>c</sup>Baltimore City - 225 mgd; 1,500,000 pop.

TABLE 14: WATER CONSUMPTION AND WITHDRAWAL, DOMESTIC AND INDUSTRIAL, 1970 & 2000, BY REGION

	URBAN WITHDRAWAL			RURAL WITHDRAWAL			PROCESSING INDUS WTHDL			FABRIC INDUS WTHDL			TOTAL
	POP <sup>a</sup> RATE <sup>b</sup>	TOTAL		POP <sup>a</sup> RATE <sup>b</sup>	TOTAL		EMPLOY <sup>c</sup> RATE <sup>b</sup>	TOTAL		EMPLOY <sup>a</sup> RATE <sup>b</sup>	TOTAL		
	(000)	gal/cap/	gal/day	(000)	gal/cap/	gal/day	(000)	gal/cap/	gal/day	(000)	gal/cap/	gal/day	(000)
<b>BALT. REG.</b>													
1970 wthdl	1725	160	276 000	305	140	42 600	96.5	5700	550 000	112.2	250	28 000	896 600
cnspl		9%	24 900		20%	8 500		8%	44 400		4%	1 120	78 920
2000 wthdl	2857	160	457 000	317	140	44 200	100	5700	570 000	122	250	30 500	1 101 700
cnspl		9%	41 200		20%	8 800		8%	45 600		4%	1 220	96 820
<b>DC, METRO</b>													
1970 wthdl	1060	160	170 000	118	140	16 500	5.2	5700	29 700	8.9	250	2 220	218 420
cnspl		9%	15 400		20%	3 300		8%	2 380		4%	89	21 169
2000 wthdl	1780	160	284 000	93	140	13 000	6.8	5700	38 800	11.7	250	2 920	338 720
cnspl		9%	25 600		20%	2 600		8%	3 120		4%	120	31 440
<b>SO. MD.</b>													
1970 wthdl	22	160	3 520	112	140	15 700	.9	5700	5 130	.3	250	75	24 425
cnspl		9%	320		20%	3 140		8%	410		4%	3	3 873
2000 wthdl	87	160	13 900	107	140	15 000	.9	5700	5 130	.9	250	225	34 255
cnspl		9%	1 260		20%	3 000		8%	410		4%	9	4 679
<b>E. Shore</b>													
1970 wthdl	49	160	7 810	149	140	20 800	11.5	5700	65 500	7.6	250	1 900	96 010
cnspl		9%	700		20%	4 160		8%	5 250		4%	76	10 186
2000 wthdl	117	160	18 700	176	140	24 600	10.6	5700	60 400	5.7	250	1 430	105 130
cnspl		9%	1 690		20%	4 910		8%	4 830		4%	57	11 487
<b>CECIL CO.</b>													
1970 wthdl	6	160	956	47	140	6 550	.3	5700	1 710	3.4	250	850	10 066
cnspl		9%	86		20%	1 310		8%	140		4%	34	1 570
2000 wthdl	15	160	2 400	45	140	6 280	.3	5700	1 710		250	970	11 360
cnspl		9%	215		20%	1 260		8%	140		4%	39	1 694
<b>TOTAL</b>													
1970 wthdl			458286			102 150			652 040			22 045	1 245 521
cnspl			41 406			20 410			52 580			1 322	115 718
2000 wthdl			776 000			103 080			676 040			36 045	1 591 165
cnspl			69 965			20 570			54 100			1 445	146 080

- a) 1970 population, by county, from Ref. 8; 2000 population projection, by county, from Ref. 9; Urban Renewal breakdown based on 1950, 1960 Census data (Ref. 10).  
 b) Rates of Withdrawal, consumption (Ref. 11).  
 c) 1970 Employment, by region, from SPD (Ref. 12); 2000 Employment extrapolations (WMRT); 2000 Equipment, different regions (Ref. 13); Processing-Fabricating Breakdown (Ref. 10).

FIGURE 16 MAJOR RAIL & WATERWAYS

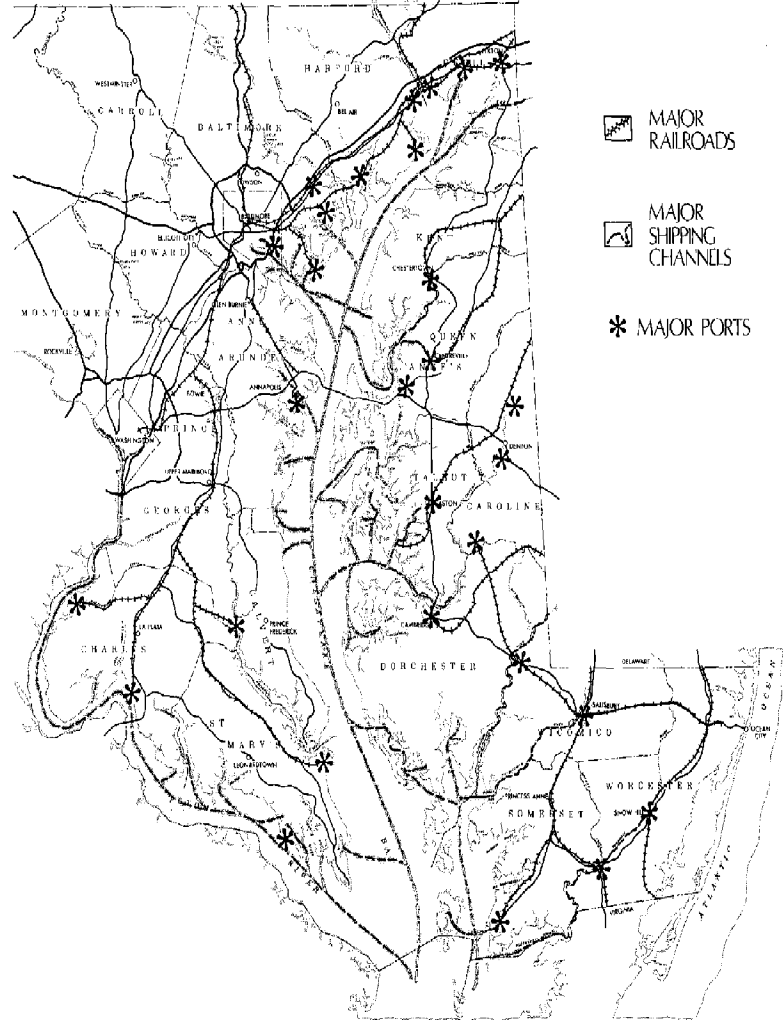

### PROBLEMS & GOALS—TRANSPORTATION

Commercial marine transportation is vital to Maryland's economy. A recent survey showed that the industrial, commercial and transportation complex making up the Port of Baltimore directs \$626.9 million a year into Maryland's economy, while providing jobs for 62,138 Marylanders. This primary impact generates, in turn, a secondary impact of almost equal magnitude, the survey says, and the combined impact for the Port of Baltimore is estimated at \$1.56 billion, which represents 11.7 percent of the Maryland gross State product.

Though marine transportation requires only a small portion of the total Bay shoreline, the facilities related directly to marine transportation have a major impact on the Bay. These include shipping channels and special facilities (e.g., the Chesapeake and Delaware Canal), harbors, special loading and unloading facilities, and port-related storage areas. In addition, significant portions of the cost of other major facilities (e.g., the Bay Bridge and Norfolk Bridge-Tunnel, the Baltimore Harbor Tunnel, the proposed water main crossing the Baltimore Harbor) can be attributed indirectly to characteristics of height and depth necessary to accommodate the needs of marine transportation (Figure 16).

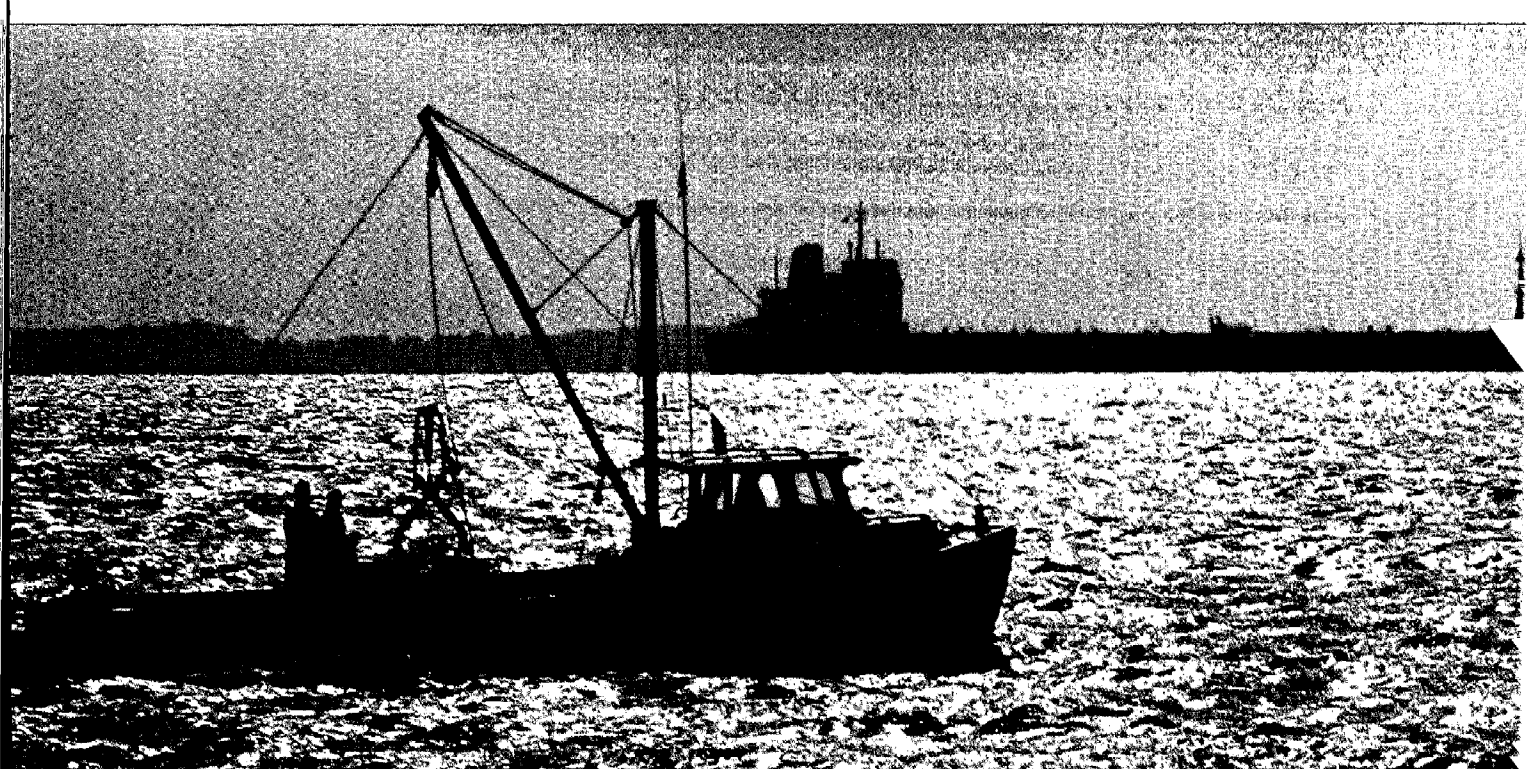
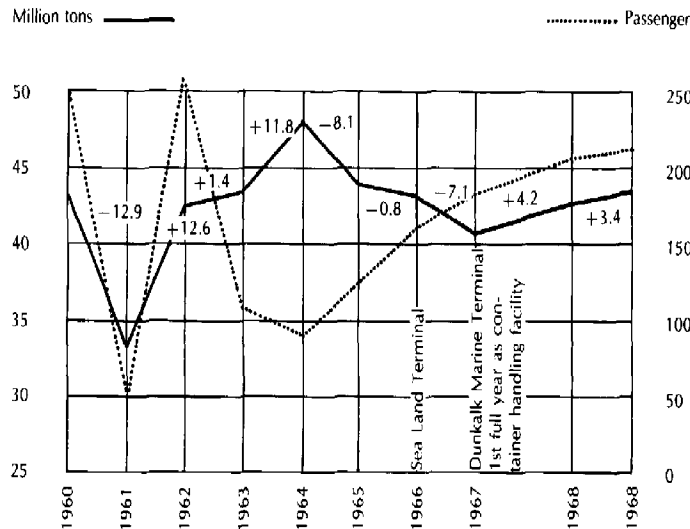

FIGURE 17 Vessel Traffic Tonnage and Annual Rates of Change: Baltimore Harbor and Channels



The problem is to maintain and increase the Bay Region's competitive position in marine transportation while minimizing undesirable ecological side-effects.

Perhaps the most significant technological change in marine transportation is the development of large, deep-draft bulk carriers. Depths required for future dry bulk carriers serving the Atlantic Seaboard may range from 42-57 feet; and channel depths required for future tankers may range from 62-72 feet. In this context, two policy questions facing Bay management can be posed: How effective would Chesapeake Bay channel deependings be in attracting future, deep-draft commercial shipping? What effects would losses in the Chesapeake Bay's competitive advantage have on Maryland's economy?

There are numerous issues regarding the orientation of future marine transportation activity in the Chesapeake Bay. One is the amount and significance and future commercial shipping oriented to Chesapeake Bay ports other than the Port of Baltimore. Technology supports the notion of a significant increase in commercial shipping activity at smaller Bay ports. However, counter-trends toward fewer and larger ports indicate that commercial shipping activity at the Port of Baltimore will continue to increase, regardless of what happens at

smaller ports, and that Baltimore will remain the dominant commercial port on the Chesapeake Bay (Figure 17).

If the average annual rate of increase in freight traffic in Baltimore Harbor since recent port modernization began is maintained in the future, freight traffic tonnage will triple by the year 2000. Because of the number and size of ships that would be using Bay shipping channels and harbors, the hazards of marine accidents would increase. Marine cargoes are likely to include increasing volumes of materials with the potential to cause major ecological damage should accidents or leakage occur. As shipping channels are deepened and transportation activities are dispersed to tributaries of the Bay, volumes of dredging spoil and costs of disposing of it are likely to increase. Continuing modernization of port facilities will require expansive port back-up areas for cargo storage and for transfer to land transportation modes. Increased demands for use of Bay waters and shoreland for recreation, leisure and aesthetic purposes will generate conflicts with increasing marine transportation activity.

**Goal: Provide for Maximum Development of Marine Transportation Based Upon Economic, Social, and Environmental Considerations**

## PROBLEMS & GOALS—WETLANDS

Marshes and other wetlands are among the Bay's most productive natural areas. They provide food and habitat for waterfowl and a variety of marine-life. The Bay is one of the most important wintering areas on the Atlantic Flyway. Nearly one million ducks and geese winter here each year.

Lack of appreciation for the natural functions which wetlands perform has often led to their destruction. Even now, when their worth is beginning to be recognized, the difficulty of assigning a monetary value to wetlands impedes proper weighting in relation to economic pressures for development.

With ownership of the Bay shoreline generally private (approximately 88 percent of the Maryland Bay shoreline), and with the present zoning structure, the management of most wetland areas has been left to local government. Government is always faced with the need to increase its tax base in order to continue supplying public services. The destruction of wetlands by diking and filling has often seemed the easiest way to make room for new industry or housing.

In response to local demand, some municipalities have ditched and drained marshes and applied pesticides to control insects. The problem is that desirable biota may be destroyed along with

mosquitoes. For example, crab larvae and copepods (tiny crustaceans that form a vital part of the Bay food-web) are extremely susceptible to pesticides. Furthermore, wetlands have been used as dumps. A statewide inventory in 1966 showed that 14 wetland areas were being used as public or municipal solid waste disposal sites. Not only does this destroy the unique value of the wetlands, but leaching from the refuse pollutes groundwater aquifers and Bay waters too.

The proliferation of small boats presents yet another pressure to fill marshes in order to construct launching ramps and marinas. However, marsh-filled for such a purpose decreases the supply of fish available to sport fishermen. Nearly one-half of marina business is linked to fishing. And fish depend in turn on wetlands for part of their life cycles.

While filling, diking, dredging, spoil-dumping, refuse disposal and water pollution are obvious threats, the indirect effects of wetland destruction on Bay water quality are less apparent. Filling of wetlands decreases the area and volume of the Bay, particularly its sub-estuaries, which—especially on the western shore—contain much of its wetland areas; and the surface area and volume of a water body help determine its capacity to assimilate wastes.

Public recognition of the problem has helped to slow the destruction of wetlands. Maryland's wetland laws, enacted in 1970, are intended to prevent dredging and filling of State wetlands without a license from the Board of Public Works, and to regulate "dredging, filling, removing or otherwise altering or polluting private wetlands." However, it is unlikely that outright destruction will be halted completely by such legislative measures because pressure for waterfront development will continue into the foreseeable future.

TABLE 16: EXTENT OF COASTAL WETLANDS IN MARYLAND (Data from 1954 Wetland surveys, published by U. S. Bureau of Sport Fisheries and Wildlife, "Wildlife Wetlands and Shellfish Areas of the Atlantic Coastal Zone.")

Freshwater Species Affected by Tides	70,330 acres
Salt Grass ( <i>Distichlis spicata</i> ) and Cordgrass ( <i>Spartina patens</i> )	64,790 acres
Needle Rush ( <i>Juncus roemerianus</i> )	53,050 acres
Saltmarsh Cordgrass ( <i>Spartina alterniflora</i> )	15,890 acres
1954 Total	104,060 acres

Table 16 shows the extent of wetlands in Maryland by dominant aquatic plant species. It has been estimated that 23,777 acres were lost to all causes between 1942-44 and 1967-68. Of these, 20,200 acres are judged to have been destroyed between 1954 and 1968.

**Goal: Preserve Wetlands in a High State of Functional Integrity**



## PROBLEMS & GOALS—BAY ALTERATIONS

### SHORE EROSION

Shore erosion can destroy recreational beaches, seriously limit waterfront use and development, and damage valuable wetlands. The 3,950-mile shoreline of the Maryland portion of Chesapeake Bay and its tributaries is subjected constantly to attack by moving water driven by winds, tides, and currents. Between 1845 and 1942, about 6,000 acres of land were lost to shore erosion along the 230-mile shoreline of the Bay proper in Maryland. During the same period, the shoreline receded several thousand feet in some areas, but remained virtually static in others (see Tables 17 and 18, and Figure 18). This is an average loss of 26 acres per mile of shoreline. The rate of erosion varies from place to place and depends on a combination of factors: the shoreline configuration; the direction and speed of prevailing and storm winds; the reach of open water over which the winds blow; the movement of sediments by off-shore currents; and the composition and structure of the materials that make up the shore.

The height of the coast varies markedly from place to place, therefore, the amount of land lost is not a direct measure of the volume of erosion. In Calvert County, the Calvert Cliffs are nearly 100 feet high; while in Dorchester County much of the shoreline is only 6 to 10 feet high. Thus, the volume of land lost may be considerably higher along Calvert County despite the slower (linear) rate of erosion when compared to the shoreline of Dorchester County. Accurate estimates of the volume of sediment lost are unavailable for most of the Bay. However, for the region from the mouth of the Susquehanna River to Tolchester in the northern Bay area, studies indicate that 4.4 million cubic feet are lost each year, representing a rate per-mile-of-shore-line of 62,300 cubic feet (Figure 19).

Increasing values of shoreline land will generate efforts to protect the shoreline from being eroded away. However, shoreland values vary widely in different areas and may not correspond to erosion protection priorities considered on a comprehensive basis. If present trends continue, the average annual loss due to erosion will be about eight acres per mile of shoreline.

	Miles of Shoreline	Net Loss 1845-1942 (Acres)	Main Shoreline Annual Erosion Rate (Acres/Miles)	Annual Volume Lost (Cu. Ft.)	Annual Rate of Volume Lost (Cu. Ft./Mi.)
Northern Bay Area					
Cecil	15.6	195	0.13		
Kent	36.9	578	0.16		
Harford	24.0	383	0.16		
Baltimore	9.3	164	0.19		
TOTAL	85.8	1,320	0.17		
Above Tolchester				4.4 × 10 <sup>6</sup>	62,300
Mid-Bay Area					
Queen Annes	17.6	592	0.34		
Talbot	11.3	286	0.28		
Dorchester	29.5	1,809	0.64		
Anne Arundel	40.3	1,041	0.30		
Calvert	31.3	530	0.17		
St. Marys	22.5	600	0.28		
TOTAL	152.5	4,858	0.34		

(Table Reproduced from Table 4 in Ref. 1)  
(Data for Col. 1-3 from Ref. 2 and 3, Col. 4 and 5, Ref. 4.)

River	Location	Physiographic Province	Drainage Area (sq. mi.)	Sediment Discharge Tons/year	Sediment Discharge Tons/sq. mi./yr.
Susquehanna	Havre de Grace,	Piedmont	27,503	1.8 × 10 <sup>6</sup>	66
Potomac	Point of Rocks, Md.	Piedmont	9,651	1.1 × 10 <sup>6</sup>	114
Potomac	Fort Washington below D.C.	Piedmont & Coastal Plain	11,939	2.3 × 10 <sup>6</sup>	180
Patuxent	Hardesty.	Coastal Plain & Piedmont.	371	8.7 × 10 <sup>4</sup>	235
Patuxent	Unity.	Piedmont	34.8	4.5 × 10 <sup>3</sup>	130
Patuxent	Mouth.	Piedmont & Coastal Plain.		.19 × 10 <sup>6</sup>	
Mattawoman Average, several	Pomonkey New Jersey	Coastal Plain. Coastal Plain.	57.7	1.7 × 10 <sup>3</sup>	30 10-40

### SEDIMENTATION

The rivers flowing into the Bay, particularly those on the Western Shore, carry enormous loads of sediment into the Bay, in addition to sediment from erosion of the Bay shoreline and bottom. Once in the Bay, these sediments are distributed over the bottom by wave action and tidal currents.

Sedimentation requires extensive continuous dredging operations, restricts the use of marinas and negates the use of wetlands by fish and wildlife. Large accumulations of sediment or increased turbidity may smother bottom-dwelling marine life.

The actual volume and rates of sedimentation vary due to a combination of factors: grain size distribution (i.e., gravel, sand, silt, clay); density of

the sediment particles; human activity in the source watershed; bottom characteristics; stream discharge and gradient; speed and direction of currents in the Bay; location in the Bay; etc. Thus, while as much as 15 feet of sediment accumulated in the Patapsco River near Baltimore between 1845 and 1924, other areas with strong bottom currents have been kept relatively well-scoured.

While the river flow into the Bay is seasonal, sediment inflow from the Potomac and Susquehanna is even more so. In early Spring, precipitation and runoff rates of meltwater are high, soils are beginning to thaw, rock and soil particles have been loosened by frost action, and there is less vegetation to hold soil in place. Thus, 80 to 90

FIGURE 18 SHORE EROSION & BAY SEDIMENTATION

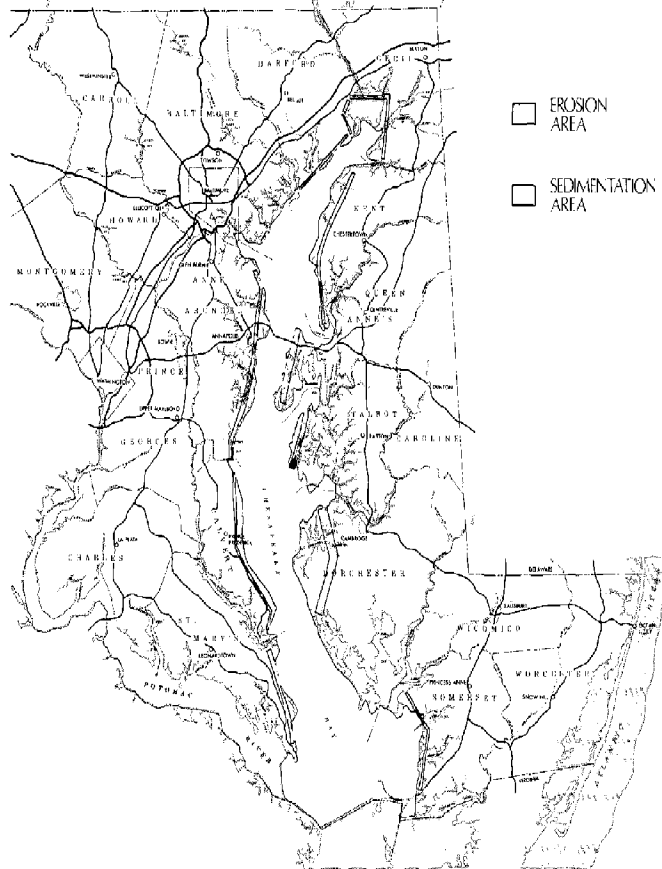
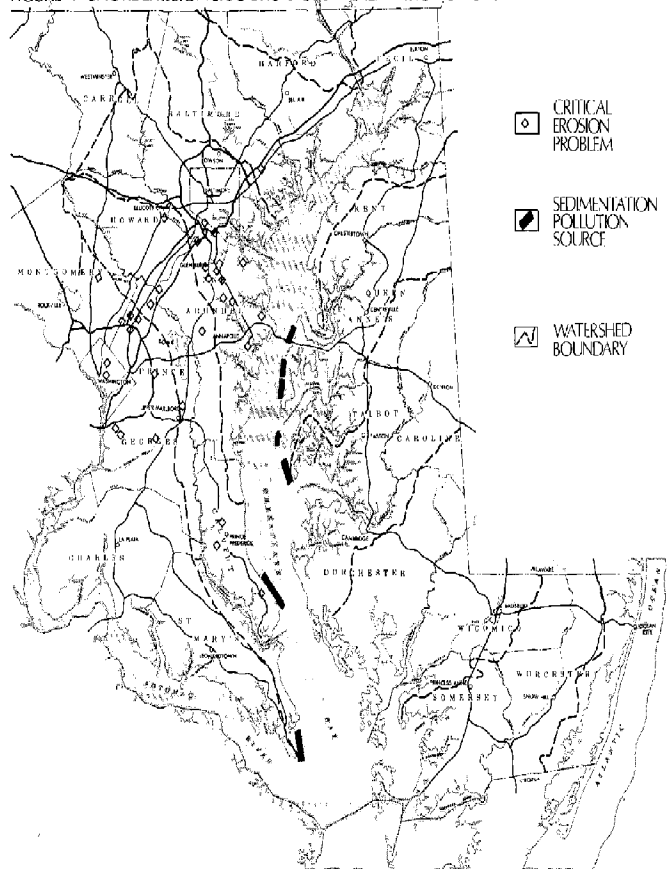

FIGURE 19 SHORE EROSION & SOURCES OF SEDIMENTATION & TURBIDITY



percent of the annual sediment load is carried to the Bay in February and March.

Current annual rates of sedimentation have been estimated at 30 tons per square mile from Coastal Plain areas and 150 tons per square mile from Piedmont Areas. Annual rates of sedimentation from land under forest cover are estimated at 100 tons per square mile. Areas under agricultural cultivation may contribute sediment at annual rates of 400 to 800 tons per square mile. Soil disturbance by construction activities increases these rates considerably, and the rate of sedimentation from developed areas remains high. Current development trends indicate that sedimentation will increase and that streams in urbanizing areas will be most affected.

Dredging operations to remove sedimentation from shipping channels incur a major maintenance cost. The annual cost of dredging in the Potomac River near Washington is about \$150,000. The annual cost of maintaining the shipping channel approaches to the Chesapeake and Delaware Canal is also about \$150,000. Data are not available on the total cost of channel-dredging operations in the Maryland Chesapeake Bay Region. However, the outlook is for costs of dredging and spoil-disposal operations to rise steadily, due primarily to increases in the total volume of material removed from shipping channels and to the cost of removal and disposal.

**Goal: Stabilize Bay Shores Against Erosion and Minimize Negative Effects of Sedimentation**

**EXTRACTABLE MATERIALS**

The demand for extractable materials such as sand and gravel is highest in areas of urban development. Transportation makes up a significant portion of the final cost of these materials, hence there is a strong economic incentive to develop sources of sand and gravel supply close to the points of demand.

Extraction of sand and gravel from on-land sites can cause a number of serious environmental effects. The open-pit extraction technique can create erosion problems. The washing of gravel can increase siltation of streams. Extraction and hauling activities can create dust and noise bothersome to nearby residents. Provisions are seldom made for reuse of the pit after extraction, and it remains an eyesore among valuable urban lands.

Extraction of sand and gravel from tributary streams, sub-estuaries and shallow Bay waters also can cause extensive environmental damage. Changes in the Bay bottom topography can change

FIGURE 20 SURFACE GEOLOGY

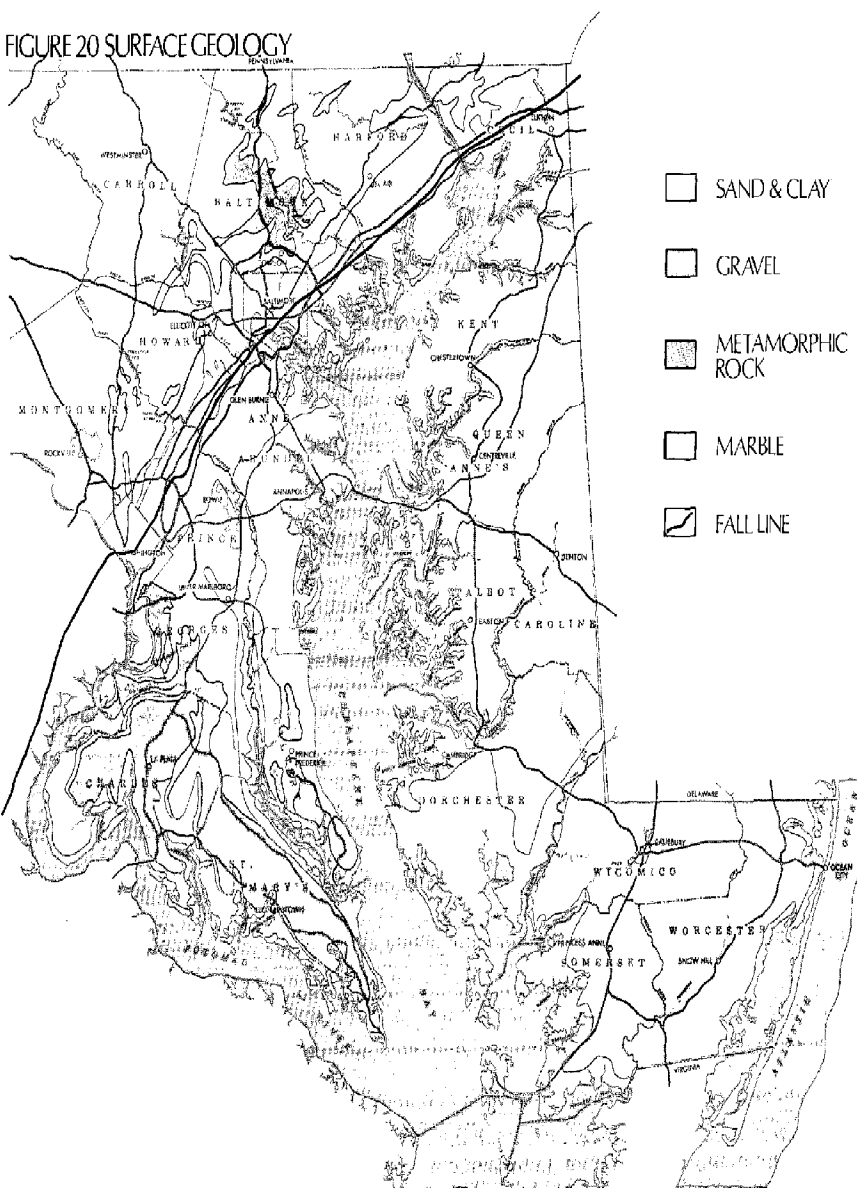



water currents which affect erosion-accretion patterns. Silt from dredging operations can increase water turbidity, which affects wetlands, aquatic life and wildfowl.

One major cause of the problem is the rapid pace of urban development which generates a substantial demand for sand and gravel. Projects ranging from highways to sand beaches increase requirements for extraction from the Bay.

Another major cause of the problem is that the concern of residents for the environmental consequences of extractive activity has placed constraints on extractive activities in many residential areas around the Bay. One result is increased pressure on the Bay as a substitute source of materials. Finally, the improving technology of dredging will make extraction from the Bay—even in deep waters—competitive with land site extraction.

The areas of urban development on the western shore of the Bay are the primary locations of demand for sand and gravel. Deposits of sand and gravel in these areas appear to be sufficient. However, there are relatively small deposits of sand off the western and eastern shores—especially in the area of the Bay off Dorchester and Somerset Counties.

Indications are that extraction from the Bay bottom is a small portion of current, total extraction activity. Marine freight traffic in sand and gravel in 1969 was about 50,000 short tons. Half of this was directed to Wicomico River port facilities, 18 percent to Nanticoke River port facilities, four percent through Choptank River facilities, and 28 percent through Baltimore Harbor facilities. Even if most of the marine freight traffic in sand and gravel was in material dredged from the Bay bottom, it would account for only 0.5 percent of total sand and gravel extraction in Maryland.

Two conclusions may be drawn. One is that the extraction of non-living resources from the Bay is a minor problem and is likely to remain so because of the difficulty and expense of such operations. Considering the small scale of extraction from the Bay bottom, the washing of sand and gravel extracted from on-land sites poses more serious water-quality problems in the Bay than does extraction from the Bay bottom. The other conclusion is that, even at low current levels, extraction of sand and gravel from the Bay bottom has significant environmental consequences.

**Goal: Provide for the Use of the Bay's Non-Living Extractable Resources With Consideration of the Possible Environmental Impacts**

**PROBLEMS & GOALS—SHORELAND DEMANDS**

**WATER-RELATED RECREATION**

The Chesapeake Bay and its shoreline lend themselves to many forms of outdoor recreation (Figure 21). The Bay proper and its irregular shoreline provide opportunities for boating of all kinds, particularly because of its many snug harbors. The sandy beaches and areas of good water quality accommodate swimming, water skiing, etc. Certain species of aquatic life offer opportunities for sport fishing,

FIGURE 21 DEVELOPED RECREATION & PUBLIC OPEN SPACE

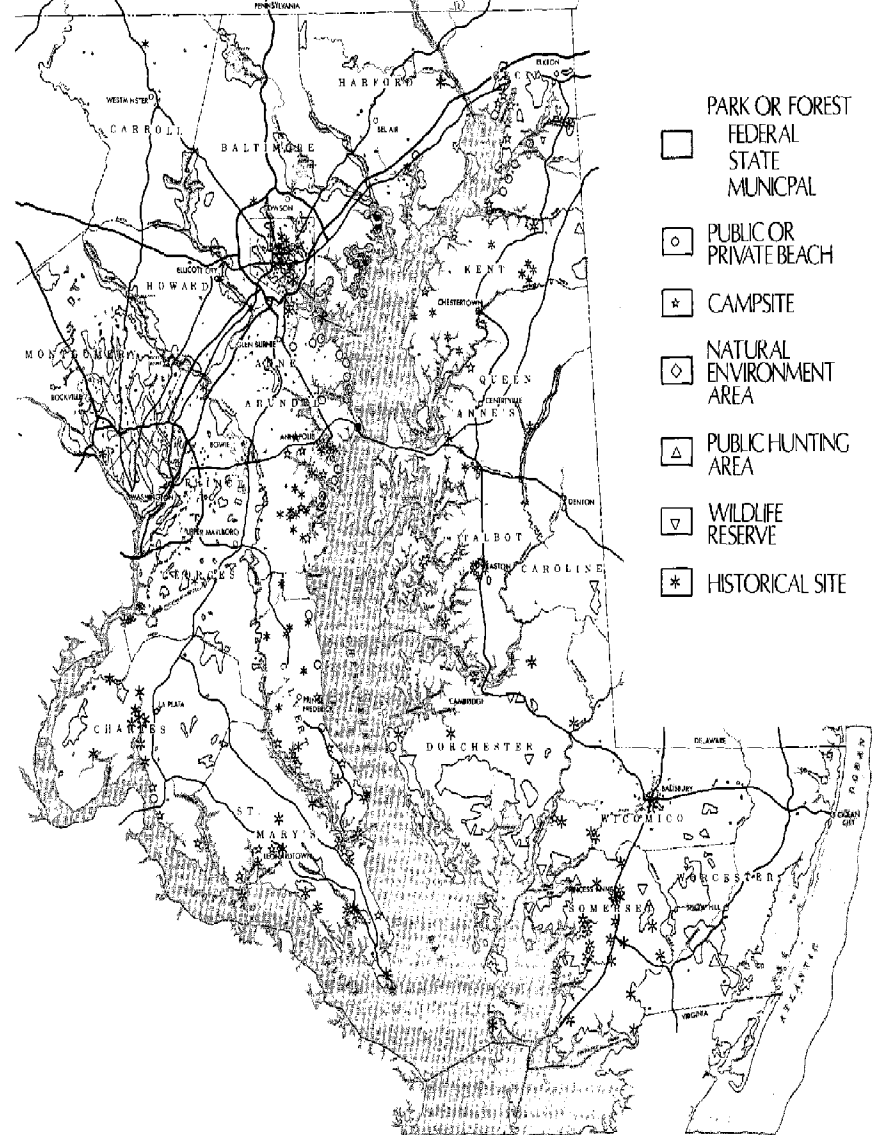



while land areas harbor wildfowl and provide opportunities for hunting. Natural scenic areas along the Bay shore promote camping, hiking, picnicking, etc.

The Bay problem with regard to outdoor recreation is to increase the opportunity for a variety of outdoor uses of the Bay while reducing potential conflicts with other Bay uses as well as the environmental damage caused by recreation users themselves.

Evaluation of recreation in terms of leisure and entertainment alone does not give a complete picture of its total value to the State. Recreation must be judged too on its role as an economic locational force. However, there is a lack of firm figures to indicate the importance of bayside recreation to the economy of the Bay area and the State.

Also unknown is the influence which recreation may have in the decision of industry to locate on or near the Chesapeake Bay. But a lack of data does not detract from the importance of recreation to the Bay area economy.

The relation between outdoor recreation and environmental quality is complex. Intensive use of recreation areas can result in damage to the very environmental qualities that were the original attraction. Also, different forms of outdoor recreation (e.g., active versus passive, boating versus fishing) can conflict.

Planning for outdoor recreation and open space is complicated by a diversity of types, needs and objectives:

- Needs in intensive urban areas—intensively developed outdoor recreation facilities within urban areas, used primarily by urban residents as day-use recreation facilities.
- Needs in intensive transitional areas—less intensively developed outdoor recreation areas that are predominantly day or weekend facilities for users from a two- or three-County area and adjacent urban and suburban developments.

- General outdoor recreation areas—extensive day, weekend, and vacation facilities, accessible (15–35 miles) to centers of urban population.
- Natural environment areas—areas which rely on the natural environment to provide recreation activities for day, weekend, and vacation use.
- Outstanding natural areas—unique and irreplaceable areas of high scenic or scientific importance which merit special protection and management to ensure preservation.
- Primitive areas—extensive, remote, wild and undeveloped areas.
- Historic and cultural areas—sites that signify the historic, traditional or cultural heritage of the Nation, State or local area.

Increases in population, mobility, and leisure will result in a 150 percent increase in the use of public

FIGURE 22 PUBLIC OPEN SPACE PROPOSALS.

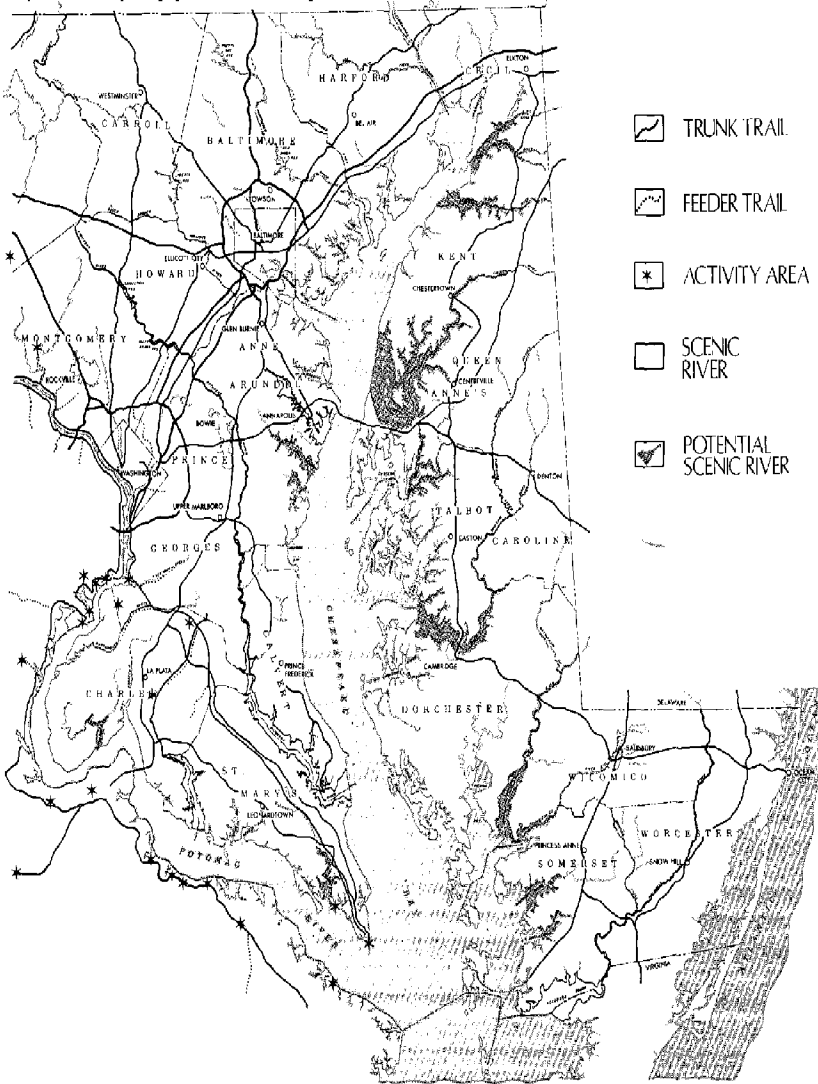

recreation facilities in Maryland between 1970 and the year 2000. In the three decades, the State's population will increase by over 2.5 million people, auto registration (mobility) will increase by 160 percent, and time free from employment will double. The demands generated by Maryland residents will be supplemented by the rapidly increasing number of out-of-state residents seeking outdoor recreation opportunities in Maryland.

Another view of the outdoor-recreation-demand picture interrelates population, income and outdoor recreation expenditures (Table 19). Per capita income in Maryland increased from \$2,343 to \$3,742 from 1960 to 1968. Adjusting for inflation at four percent, this represents a real income gain per capita of over \$500.

For each dollar change in income, expenditures on recreation change \$1.50 to \$2.00. Assuming that population will increase according to current projections and that real per capita income will continue to rise at the 1960-68 rate, gross expenditures for recreation in the Maryland Bay Region

TABLE 19: ECONOMIC IMPACTS OF RECREATION DEMAND AND EXPENDITURES: 1960-2000

	Maryland Population Over 12 Yrs. Old (Except W. Md.) <sup>a</sup>	Per Capita Annual Expend. Away from Home on Vacations, Outdoor Rec. Trips, and Outings <sup>b</sup>	Gross Recreation Expend. in Md. Bay Region (in Millions of Dollars) <sup>c</sup>	Recreational Expenditures for Water-Based Recreation (in Millions of Dollars) <sup>d</sup>	Economic Impact of Expend. for Purposes of Water-Based Rec. (in Millions of \$) <sup>e</sup>	Impact to Rural Income From Expend. on Water-Based Rec. (in millions of \$) <sup>f</sup>
1960	2,090,000	\$103.7	\$208.	\$ 83	\$125	\$ 63
1970	2,650,000	\$139.0	\$368	\$147	\$221	\$110
1980	3,220,000	\$192.0	\$618.	\$248	\$372	\$186
1990	3,690,000	\$260.0	\$960	\$384	\$577	\$288
2000	4,090,000	\$428.0	\$1750	\$700	\$1050	\$525

<sup>a</sup>Population over 12 yrs. = 74% of Total Population (see Md. Statistical Abstract, p. 13)

<sup>b</sup>1960 Expend. from ORRRC Report #19; assumes 1960-68 Rate of Increase in Per Capita Income, adjusted for inflation at 4%; assumes income elasticity of recreation at 1.5 (See NAR: Effects of Rec. Devel., Nov. 1969, p. 5) applied to real increases in income after 1960.

<sup>c</sup>In actual dollars (See Note #2); assumes rec. expend. of Md. Bay Region residents outside region = rec. expend. of outside residents in Md. Bay Region.

<sup>d</sup>40% gross rec. expend.: on basis of major purpose of trip (See NAR, *ibid.*, p. 10, 11)

<sup>e</sup>Multiplier for rec-related expend.: \$1.50 (NAR, *ibid.*, 14, 15)

<sup>f</sup>Assumes 50% of Total Inc. increase spent in rural areas (NAR, *ibid.*, p. 17)

FIGURE 23 PROPOSED OPEN SPACE & OUTDOOR RECREATION SYSTEM

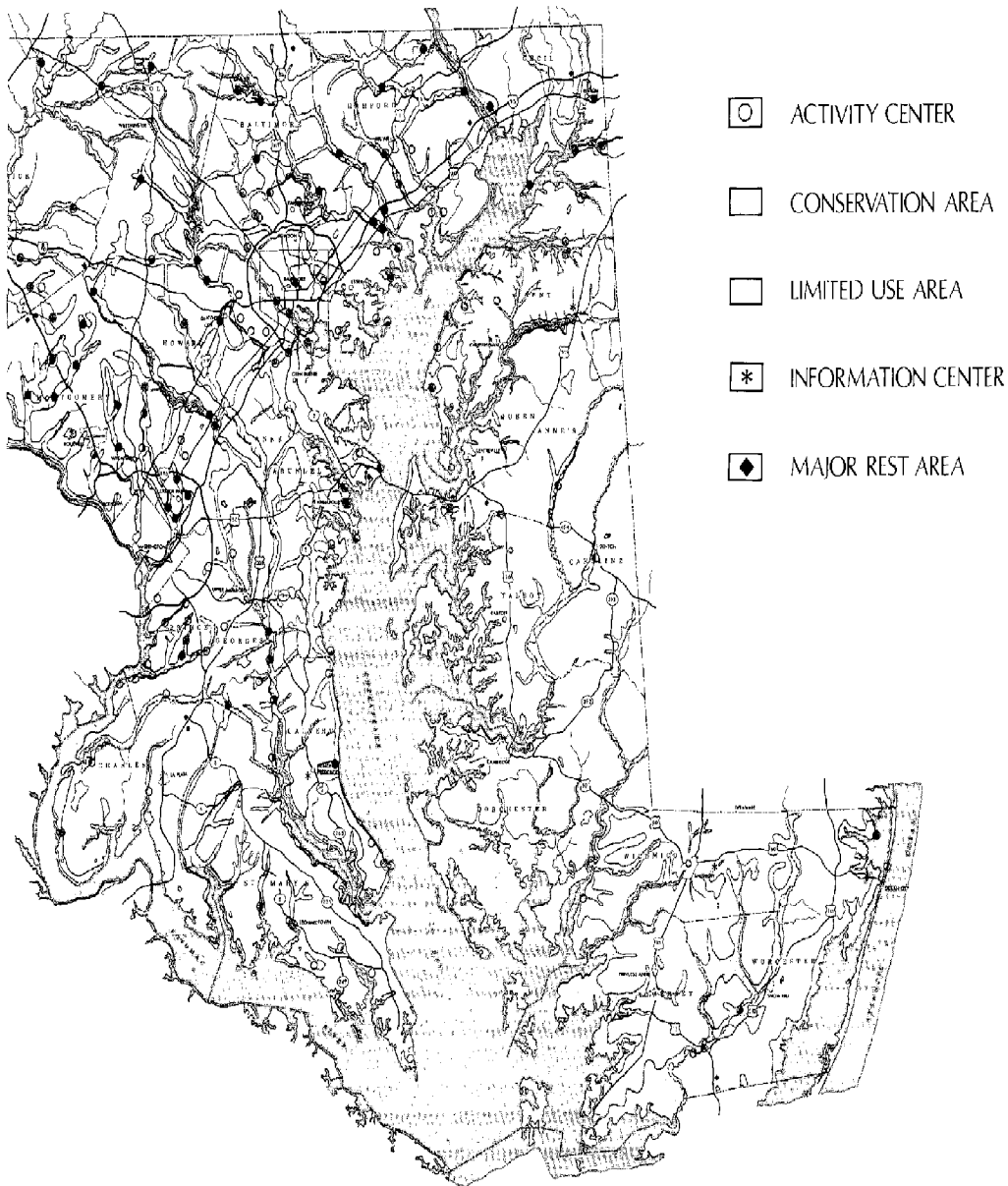

may multiply four times by the year 2000; and half of the total will be water-based recreation-oriented primarily to the Bay.

Statewide, swimming will increase by 75 percent, picnicking by 65 percent, fishing by 80 percent, and boating, hunting, camping and water

skiing will double. Expenditures associated with trips for which water-related recreation is the major purpose may increase five times between 1970 and 2000 in Maryland. Much of the outdoor recreation potential and demand represented by these state figures will focus on the Bay and its tributaries.

The Maryland Outdoor Recreation and Open Space Plan indicates that year 2000 outdoor recreation and acreage needs in the Baltimore and Suburban Washington regions will be six times the 1970 acreage. Because of intense competition for various water and shoreline uses in these regions, it may be impossible or undesirable to attempt to meet the water-related recreation needs of Maryland's metropolitan population within metropolitan counties. This would indicate an increased emphasis on outdoor recreation uses in non-metropolitan regions of the State. If half of the public open space and outdoor recreation acreage needs of the metropolitan counties are supplied in non-metropolitan regions of the State, then the required additional water-related recreation acreage would be 142,000 acres between 1970 and 2000. This prospect has significant economic potential for non-metropolitan areas of the State.

Rapid urbanization on the Western Shore of the Bay will consume much land now suitable for outdoor recreation opportunities and will drive up the cost of land acquisition for outdoor recreation. Thus, it will become increasingly difficult to find and acquire the acreage needed. The Maryland Outdoor Recreation and Open Space Plan indicates that by the year 1990, 124,000 additional acres for public open space and outdoor recreation will be needed in the Baltimore Region, 103,300 acres in the Suburban Washington Region and 69,100 acres in the Southern Maryland Region (The adjoining tables point up the current Baltimore, Suburban Washington, Southern Maryland and Eastern Shore deficiency of nearly 163,000 acres.

Increasing use of the Bay shoreline for private year-round and vacation homes imposes another constraint on water-related recreation land supply. Other uses which benefit from a shoreline location—industries, powerplants, etc.—will place additional demands on the supply of available water-related recreation land. The increase of incompatible water uses, especially the use of the Bay for solid and liquid waste disposal is another threat to the supply of water-related recreation land.

**Goal: Maximize Opportunities for Water-Related Recreation**

TABLE 20 GENERAL RECREATION LAND REQUIREMENTS & DEFICITS FOR STATE & REGIONS (In Acres for 1970 & 1990)\*

Planning Regions	Year 1970			Year 1990		
	Requirements	Supply (1970)**	Deficit & Excess	Requirements	Supply (1970)**	Deficit & Excess
Western Maryland and Frederick Region	29,859	135,825	+105,966	61,193	135,825	+74,632
Suburban Washington	64,725	22,075	-42,650	125,355	22,075	-103,280
Baltimore	89,494	50,805	-38,689	174,850	50,805	-124,045
Southern Maryland	37,340	7,258	-30,082	76,401	7,258	-69,143
Upper Eastern Shore	36,886	9,319	-27,567	83,950	9,319	-74,631
Lower Eastern Shore	34,147	10,051	-24,096	69,577	10,051	-59,526
State of Maryland	292,451	235,333	-57,118	591,326	235,333	-355,993

\*Figures exclude wildlife management areas, hunting requirements and water surface area requirements because they tend to distort the total figures.  
 \*\*Based on Maryland Department of State Planning Recreation Inventory, conducted 1971.  
 \*\*\*Based on assumption that no new acres would be provided between 1970 and 1990.

TABLE 21 GENERAL RECREATION LAND REQUIREMENTS & DEFICITS FOR STATE & REGIONS INCLUDING WILDLIFE MANAGEMENT AREAS (In Acres for 1970 & 1990)\*

Planning Regions	Year 1970			Year 1990		
	Requirements	Supply (1970)**	Deficit & Excess	Requirements	Supply (1970)**	Deficit & Excess***
Western Maryland	29,859	155,095	+125,236	61,193	155,095	+93,902
Frederick Regions	64,725	24,013	-40,712	125,355	24,013	-101,342
Suburban Washington	89,494	51,414	-38,080	174,850	51,414	-123,436
Baltimore	37,340	8,129	-29,211	76,401	8,129	-68,272
Southern Maryland	36,886	12,231	-24,655	83,950	12,231	-71,719
Upper Eastern Shore	34,147	73,362	+39,215	69,577	73,362	+3,785
Lower Eastern Shore	292,451	324,244	+31,793	591,326	324,244	-267,082
State of Maryland						

\*Figures exclude hunting requirements and water surface area requirements because they tend to distort the total figures.  
 \*\*Based on Maryland Department of State Planning Recreation Inventory, conducted 1971.  
 \*\*\*Based on assumption that no new acres would be provided between 1970 and 1990.

## WATERFRONT INDUSTRY

The Baltimore Region is faced with the prospect of a doubled population by the year 2000. To support this population the Region must look into its unique economic assets; the greatest of these is its Port. Shorefront sites with deep-draft water accessibility are needed by an increasing number and variety of industries. Further, it is evident that the space needs of new waterfront industries will be greater than those of shorefront industries built in the past. Only three percent or eight miles of the 266-mile Baltimore Region shorefront is vacant, unrestricted by ownership, and suitable for deep-draft transport. Reservation of most of these eight miles for future waterfront industry is in the national interest.

Some constraints on the supply of waterfront land suitable for industrial development are: access to deep-water channels; competition with alternative land uses; and resistance from affected, existing uses. Moreover, changing technology of industrial production generates changing demands for industrial land. The result is a shortage of suitably located, suitably serviced land for waterfront industry—a potential limitation on the growth of the regional economy.

Land allocated to waterfront industry often limits public access to the water where the need for public access is greatest. The Baltimore Harbor is the most important example in the Maryland Chesapeake Bay area. There the development of deep water channels, modern loading and unloading facilities, and supporting highways and railroads make land adjacent to the waterfront suitable for industrial use. At the same time, however, the urban population surrounding the Harbor is cut off from the waterfront by the spread of industry.

Development of waterfront industry on the few available shorefront sites with potential deep-draft water transportation can have environmental consequences so complex that it is inaccurate to portray the issue as a simple confrontation of development and conservation objectives.

Two studies—one completed in 1963, the other in progress—provide an interesting perspective on planning for waterfront industry in the Baltimore Harbor area. Both studies communicate a strong sense of urgency in stressing the scarcity of shorefront sites with potential deep-draft transportation in the Baltimore Region and the need to control

environmental impacts of waterfront industrial development and operations by means of pollution abatement plans.

One current, major cause of problems relating to waterfront industrial land is the technological change in marine transportation, to which local industries must respond in order to remain competitive with other ports on the Atlantic Seaboard. Such changes include the need to accommodate large, deep-draft tankers which require deep shipping channels; the need to utilize specialized loading

and unloading facilities in order to reduce “turn-around time” for harbor visits; and the need for large storage areas adjacent to the waterfront to handle increased volumes of cargo. Related changes are those in basic industry production processes which require larger industrial sites and more extensive supportive services (e.g., water supply, and rail or highway linkages).

These determinants do not, of course, affect all industries in the same way (Figure 24). Industries which can use shallow draft coastwise shipping



could utilize land adjacent to shallow channels; and, since shipments are generally smaller, they can use smaller storage areas. Industries which need large volumes of water (e.g., electrical power generation) can sometimes dispense with a harbor location altogether—provided adequate highway or rail transportation is available.

The cumulative, net effect of these factors has often been to make formerly adequate waterfront industrial sites obsolete. The search for waterfront land suitable for modern industry has resulted in the

migration of the Baltimore Harbor waterfront industry southward along the banks of the Patapsco River, while the abandonment of obsolete industrial sites has left a deteriorated, difficult-to-renew physical environment which requires heavy investment to transform it to other useful purposes. This has worsened problems of metropolitan population access to waterfront land, has consumed recreation land, and has reduced the value of nearby recreation areas. Converting the abandoned waterfront land to alternative uses is a slow and difficult pro-

cess.

The Baltimore Regional Port Area has only two large, potential deep-draft sites not zoned for industry. On Back River, in Baltimore County, a site of 1,500 to 1,700 vacant acres with over one mile of vacant shoreline in a few large ownerships, is one of the few remaining large waterfront sites in metropolitan regions on the eastern seaboard. Hog Neck, in Anne Arundel County, has approximately 1,100 acres vacant, held in multiple ownership. An additional, adjacent 800 acres, also in multiple

FIGURE 24 MANUFACTURING EMPLOYMENT CENTERS:

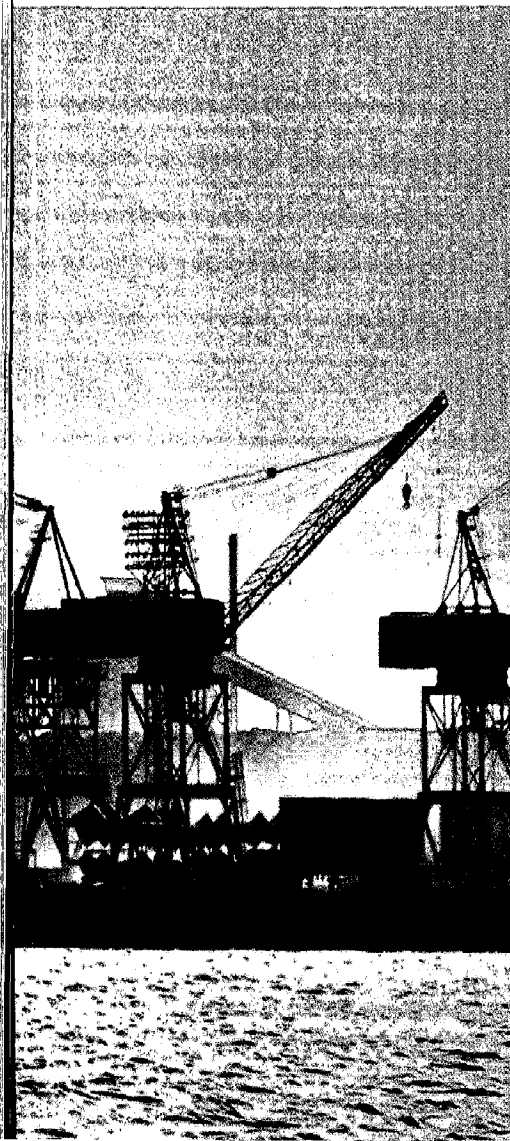
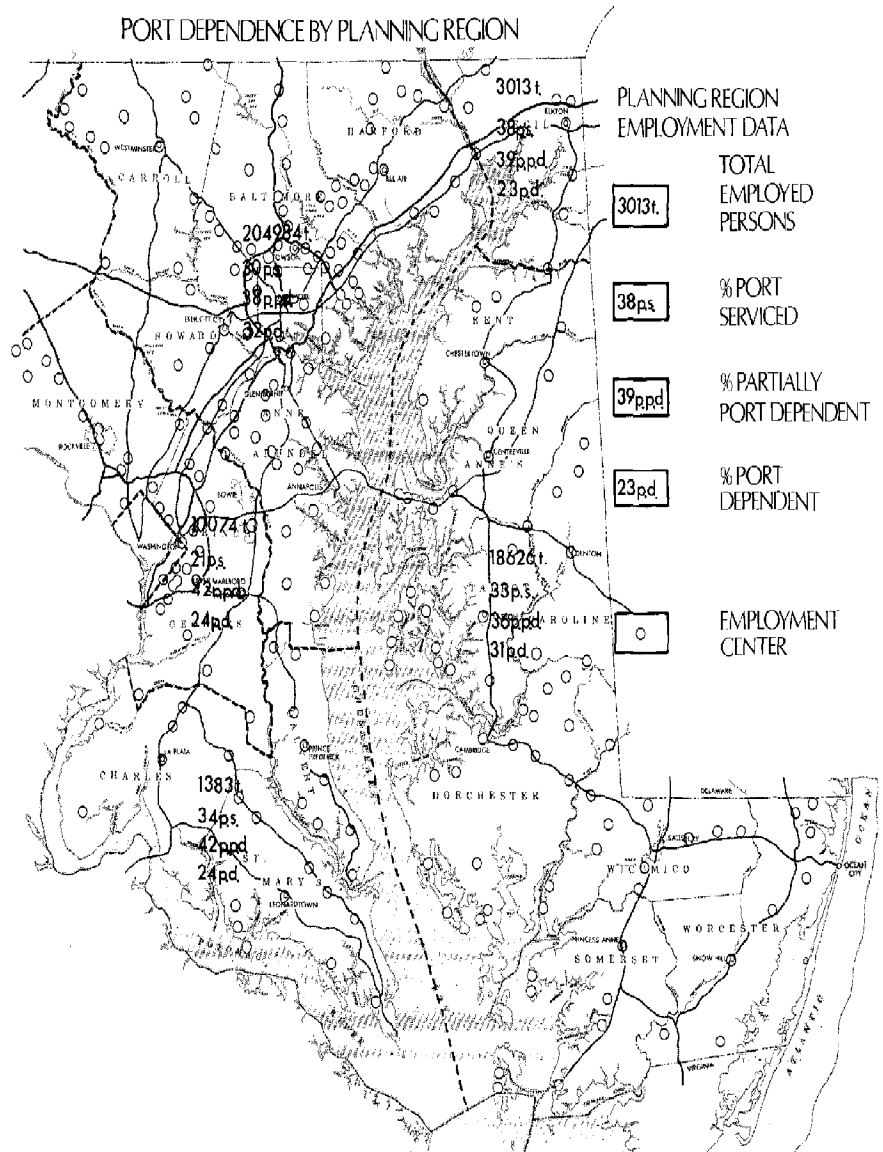

ownership, are interspersed with roads and some residential development.

Problems relating to the supply of land for waterfront industry and conflicts between waterfront industry and other urban and environmental shoreline uses are most apt to arise in metropolitan areas which offer ready access to consumer and manufacturing markets, a broad range of supporting facilities and services, and harbor facilities (Table 22).

The development of shallow draft shipping may enable more Chesapeake Bay ports to compete effectively (with both deep-water harbors and highway-oriented industrial sites) for waterfront industry. This could result in a relative dispersal of waterfront industry to small port facilities on the Eastern and Western shores.

Conflicts are increasing between waterfront industrial uses and recreational, residential, open space and transportation uses. These conflicts are particularly intense in metropolitan areas where the demand for waterfront locations is large and where the supply of available shoreline land is small. Such conflicts will intensify in areas proposed for industrial use and will increase the difficulty of making suitable waterfront sites available for industry. Likewise, industry will compete with other uses for water in urban areas.

In 1970, self-supply industrial water use was about 103 billion gallons per day. Public water supplied to industry and households was only 35 billion gallons per day. Industrial water use continues to increase faster than public water use.

Wastes discharged by industry will generate conflicts with water-related recreation, commercial fishing, open space and other uses. Even if wastes discharged by industry are held at present levels, it is likely that increases in activities which depend on higher levels of water quality will generate increasing difficulties for waterfront industrial location.

Finally, the rising cost of preparing land for waterfront industry will compound the difficulties of port-related industrial development. Site preparation costs are particularly heavy in estuarine environments such as the Bay.

**Goal: Maximize Bay Opportunities for Water-Related Industry**

TABLE 22:  
PORT-DEPENDENT MANUFACTURING EMPLOYMENT, BY COUNTY

COUNTY		CANNED & CURED FISH & SEAFOOD	FRESH OR FROZEN PKGD. FISH & SEAFOOD	CANE SUGAR REFINING	INDUSTRIAL INORGANIC & ORGANIC CHEMICALS	AGRICULTURAL CHEMICALS	PETROLEUM REFINING	CONCRETE GYPSUM & PLASTER PRODUCTS	PRIMARY METAL INDUSTRIES	SHIP & BOAT BUILDING & REPAIRING	TOTAL
Anne Arundel	-Employ		113		328	120		277	818	496	2,152
	-Firms		2		2	2		11	3	27	47
Balt. City	-Employ	56	37	700	2,750	866	70	1,231	5,883	5,584	17,177
	-Firms	4	4	1	23	12	1	19	33	9	106
Balt. County	-Employ				97	15		889	33,393	5,672	37,066
	-Firms				6	1		17	11	4	39
Carroll	-Employ					19		118	12		149
	-Firms					2		4	1		7
Harford	-Employ				130			354	80	9	573
	-Firms				2			9	1	1	13
Howard	-Employ							141			141
	-Firms							4			4
Calvert	-Employ									108	108
	-Firms									2	2
Charles	-Employ							92			92
	-Firms							3			3
St. Marys	-Employ		77					31		28	136
	-Firms		4					2		3	9
Caroline	-Employ		110			6		17			133
	-Firms		1			1		2			4
Dorchester	-Employ		743			81		13	75	10	922
	-Firms		17			1		1	1	3	23
Kent	-Employ	550	56		48	8				25	687
	-Firms	1	2		1	2				2	8
Queen Annes	-Employ		548					54		10	612
	-Firms		12					3		2	17
Somerset	-Employ	7	945						150	12	1,114
	-Firms	1	24						1	1	27
Talbot	-Employ		1,435					21		68	1,524
	-Firms		11					2		8	21
Wicomico	Employ		70			52		127	53	594	896
	-Firms		2			3		7	2	3	17
Worcester	-Employ		21			67		64	6		158
	-Firms		1			2		3	1		7
Montgomery	-Employ				13	31		187	93		324
	-Firms				1	2		8	3		14
Prince George	-Employ				380			976	131		1,487
	-Firms				3			23	4		30
Cecil	-Employ				19			53	375	623	1,070
	-Firms				2			4	1	5	12

Source: "Maryland Manufacturers" Directory 1969-70, Maryland Department of Economic Development.

NOTE: Data include all employees of firms in the listed "Port-Dependent" manufacturing classifications, even though some firms engage in "Non-Port-Dependent" operations.



## WATERFRONT RESIDENTIAL

Residential development of the shoreline and peninsular areas, particularly along the western shore of the Bay, is a major potential. These areas combine the amenities of the Bay with proximity to suburban metropolitan jobs. The eastern shore also has major potential for vacation and retirement residential development but it is farther from metropolitan centers. As more persons seek to combine recreational opportunities with basic shelter needs, residential development of the Bay shoreline will increase. However, present low density shoreline development has preempted long stretches of waterfront with a few houses and has, in the process, denied waterfront access to adjacent inland areas. In this way, the residential development potential of the shoreline as a whole has been greatly reduced.

Low-density, relatively uncontrolled development along the shoreline has preempted the land, while the manner of development has had some severe effects on the environment. Heavy water runoff into the Bay and small streams has increased erosion and sedimentation, clogging natural stream channels and wetlands. Much of the soil next to sub-estuaries is highly permeable, and liquid waste effluent leaches from septic tanks into the water. Water is drawn from aquifers near the Bay and salt water from the Bay infiltrates the aquifers.

Maryland's population is projected to continue to increase—by two million persons between 1970 and the year 2000—and many of the new people can be expected to locate on or near the Bay shoreline. In the Baltimore Region, preliminary calculations indicate that the population of peninsula areas will increase by 23,000 persons per year. If so, peninsula areas would absorb 65 percent of the projected population increase of the metropolitan area. By the year 2020, 1,140,000 persons may live in peninsula areas in the Baltimore Region.

It is likely that a similar proportion of the population increase in other counties bordering the Bay will locate in peninsula areas. If so, the population of peninsula areas in the Maryland Bay Region will increase by 27,000 persons per year, or by 810,000 persons between 1970 and the year 2000.

Calculations indicate that residential develop-

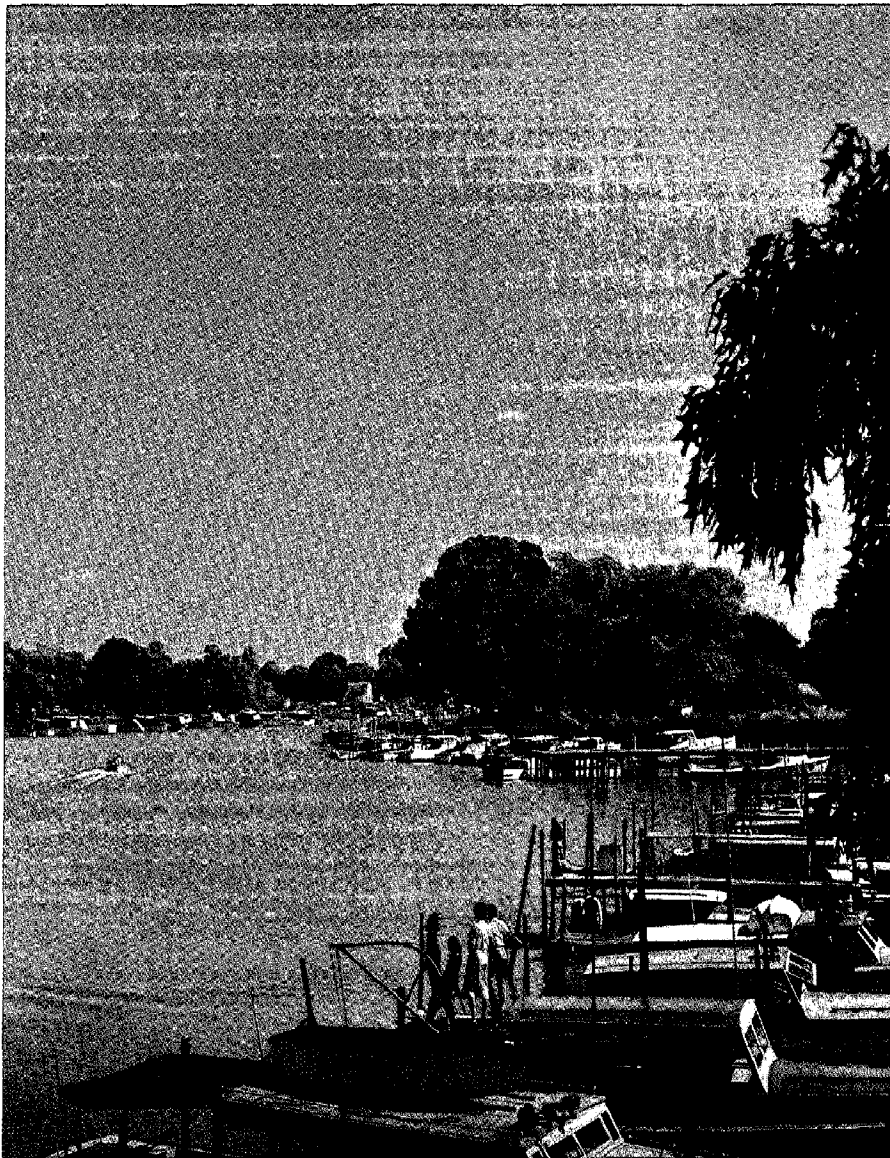

ment in peninsular areas will proceed at a rate of 9,000 year-round dwelling units and 2,000 vacation dwelling units per year. Most of the year-round dwelling units will be built on the fringes of urbanizing areas of the western shore. It is reasonable to assume that 165,000 acres of Bay shoreline will be developed for residential use between 1970 and the year 2000.

But the issue is not characterized adequately in terms of the volume and acreage of residential de-

velopment. Rather, the issue is residential development under certain environmental conditions, particular densities, and in combination with other uses. Trends indicate that development will preempt large stretches of shoreline for a fraction of potential demand, and that environmental values will suffer in the process.

**Goal: Maximize Opportunity for Bay Waterfront Residential Development**

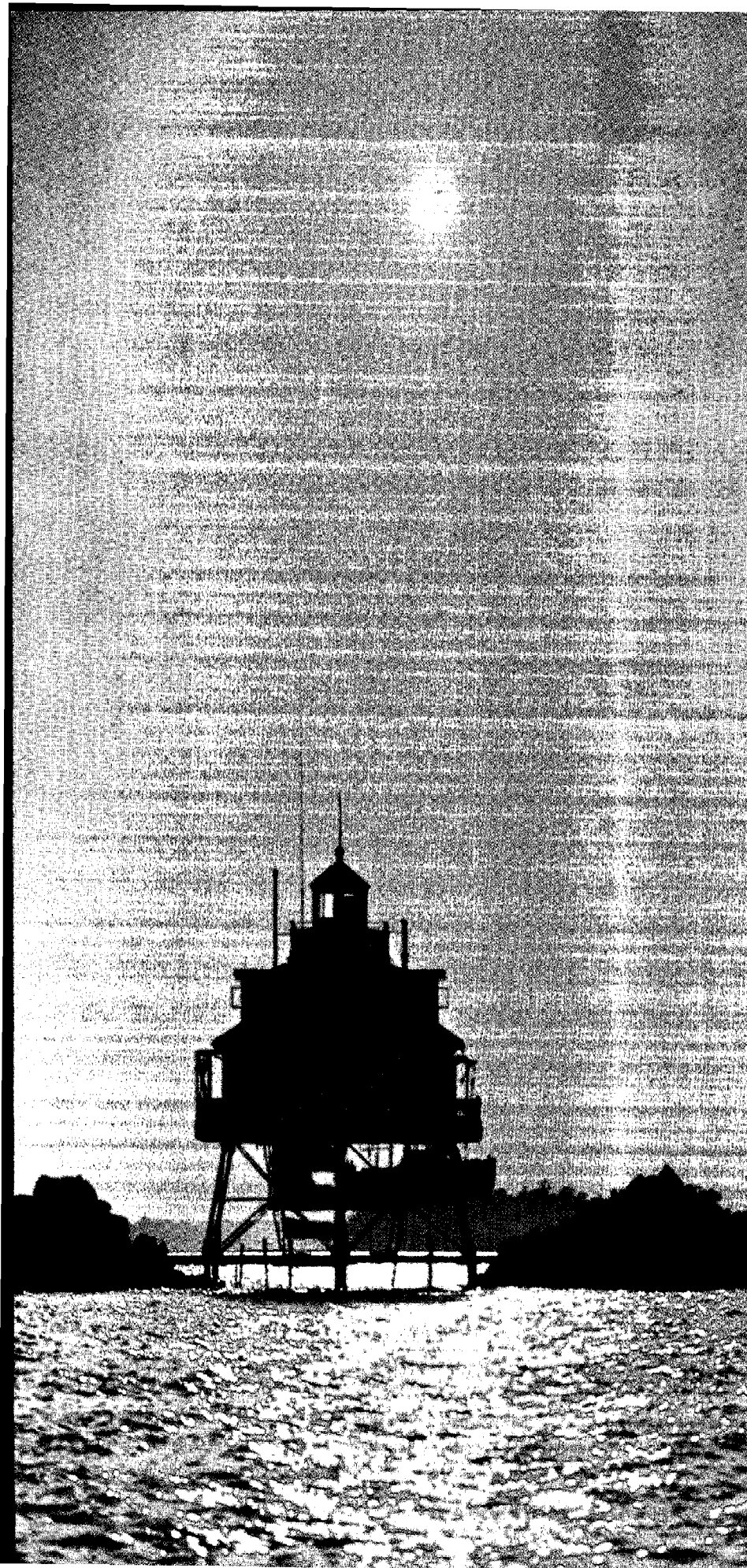

## PUBLIC ACCESS

The general public has little access to the Chesapeake Bay shoreline. This situation stems in part from the geography of the Bay. Major roads have been built inland where expensive crossings of subestuaries feeding the Bay were not necessary. Also, the lack of public access is due to extensive private use of shoreline areas (only three percent is publicly owned). Some of the privately owned land is in industrial and institutional use, but the major portion is low density residential.

The problem of public shoreline access is most severe on the Bay's western shore where most of the public lives which would benefit from access. It is also on the western shore that the most dramatic possibilities and proposals exist for providing public access to the Bay, e.g., reuse of part of the Aberdeen Proving Ground/Edgewood Arsenal for public shoreline access; the major park proposals for the Susquehanna River and Patuxent River; development of public vista points in the Baltimore Harbor; public parkland acquisition programs such as that now underway by Baltimore County.

It becomes more difficult and expensive each year to reclaim obsolete waterfront development areas for public recreational access. Local government is hard-pressed to provide basic services and to acquire shoreline land.

Problems of public shoreline access and shoreline appearance will probably increase. And as demands focus increasingly on a few limited areas, the appearance and quality of these areas will decline. Active pursuit of a variety of approaches to providing public shoreline access could reverse the trend; however, difficulties of maintaining the appearance of the shoreline are likely to increase.

**Goal: Maximize Public Access to the Bay, and Enhance the Appearance and the Aesthetic Character of the Shoreline**

Summary of the Chesapeake Bay's Present and Emerging Problems by Geographic Area

	Water Environment	Environmental Quality	Fish & Wildlife	Water Supply	Transportation	Wetlands	Bay Alterations	Shoreland Demands	Remarks
WESTERN SHORE	Major	Major	Major	Major	Major	Major	Major	Major	
EASTERN SHORE	Major	Major	Major	Major	Major	Major	Major	Major	Emerging Water Supply Problem
CBIPC STUDY AREA	Major	Major	Major	Major	Major	Major	Major	Major	Emerging Thermal Discharge Problem



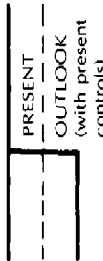

 MAJOR   
  SIGNIFICANT   
  INSIGNIFICANT

The "Summary of the Chesapeake Bay's Present and Emerging Problems" matrix, which summarizes the essence of Chapter Four, calls attention to problem areas in the Chesapeake Bay. The magnitude and severity of change are based upon assumptions predicated in previous sections of the Chapter.



Summary of Chesapeake Bay Goal Conflict and Compatibility

GOAL	WATER ENVIRONMENT	ENVIRONMENTAL QUALITY	WATER QUALITY	SOLID WASTE	THERMAL WASTE	FISH AND WILDLIFE	WATER SUPPLY	TRANSPORTATION	WETLANDS	BAY ALTERATIONS	EROSION-SEDIMENT	EXTRACTABLE RESOURCES	SHORELAND DEMANDS	WATER RECREATION	WATERFRONT INDUSTRY	WATERFRONT RESIDENTIAL	PUBLIC ACCESS
WATER ENVIRONMENT																	
ENVIRONMENTAL QUALITY																	
WATER QUALITY																	
SOLID WASTE																	
THERMAL WASTE																	
FISH AND WILDLIFE																	
WATER SUPPLY																	
TRANSPORTATION																	
WETLANDS																	
BAY ALTERATIONS																	
EROSION-SEDIMENT																	
EXTRACTABLE RESOURCES																	
SHORELAND DEMANDS																	
WATER RECREATION																	
WATERFRONT INDUSTRY																	
WATERFRONT RESIDENTIAL																	
PUBLIC ACCESS																	

 MUTUALLY SUPPORTIVE   
  MINOR CONFLICT  
 COMPATIBLE OR NEUTRAL   
  LIKELY CONFLICT

The Summary of Chesapeake Bay Goal Conflict and Compatibility Matrix, which provides a compilation and ready-reference of Chapter Four, calls attention to the interrelationship of goals for the Chesapeake Bay. The relative degree of conflict or compatibility is based upon assumptions predicated in previous sections of this Chapter.



*"OUR ENVIRONMENT IS AS MUCH A PART  
OF OUR HERITAGE AS OUR CULTURE. WE  
MUST NURTURE IT, AND PROTECT IT, SO  
THAT IT CAN BE PASSED ON TO COMING  
GENERATIONS"*  
GOVERNOR MARVIN MANDEL

THE NEXT STEP



**THE NEXT STEP**

**ELEMENTS OF A COMPREHENSIVE PLAN**

Previous sections of this report indicate the complexities of Baywide planning and management. Even though the challenges are formidable, comprehensive evaluations are required to provide effective guidance to all levels of government. Prior to the preparation of a "Comprehensive Plan", however, the steps in the process must be identified to insure that duplications and gaps are avoided. This process is illustrated in two charts: "Elements of a Chesapeake Bay Comprehensive Planning System" and "Scheduling of Elements for a Chesapeake Bay Plan."

The "Comprehensive Plan", as distinguished from the second phase, "Management Plan", focuses on meshing the five major elements and 24 sub-elements into a comprehensive framework which culminates in goals, policies and alternatives. The elements and sub-elements will be prepared utilizing where possible available data and existing program information. The "Comprehensive Plan" developed with effective citizen input and participation seeks to resolve conflicting Bay activities into a compatible resource framework.

The second phase, "Management Plan", is an outgrowth of the "Comprehensive Plan". This portion of the overall Chesapeake Bay planning system will serve to identify the logical governmental agencies and levels to carry out various aspects of the "Comprehensive Plan". Major items included in this endeavor would be functional, identification, fiscal support and program scheduling. Again, during this phase of the overall planning system, citizen participation will be of substantial value.

Phase three, "Implementation Plan", will be oriented primarily toward functional operation, regulation and control; based upon the "Management Plan".

**INSTITUTIONAL ALTERNATIVES**

Institutional concepts have been developed by Wallace McHarg Roberts & Todd, Inc. to fulfill generalized criteria for comprehensive planning and management planning and to take full advantage of expertise contained in existing state agencies; each alternative is discussed below and summarized in Chart 3. Other institutional possibilities by CBIPC member agencies may be forthcoming.

**GENERAL CRITERIA AND THE CONCEPTS**

The capabilities of a Baywide planning organization should include: information, research, planning, citizen participation and feedback. In

Chart 1  
ELEMENTS OF A CHESAPEAKE BAY COMPREHENSIVE PLANNING SYSTEM

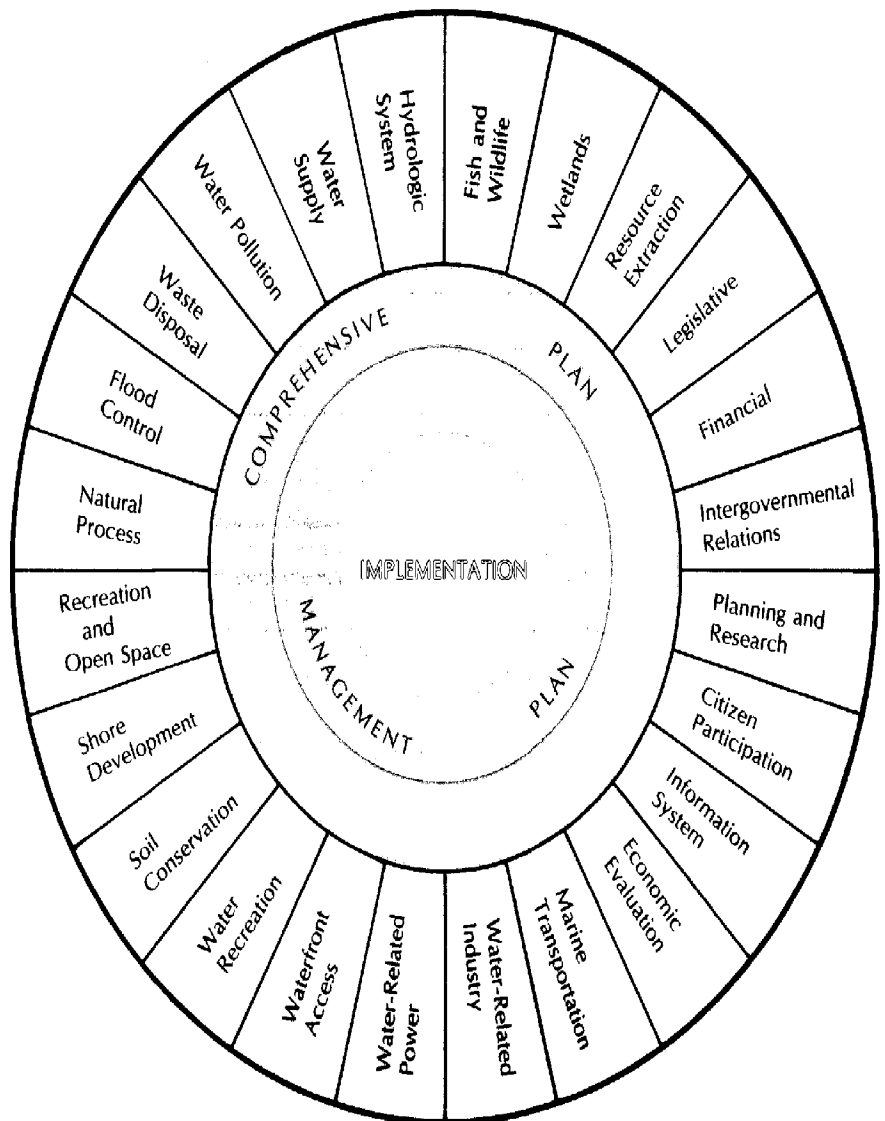

Chart 2  
SCHEDULING OF ELEMENTS FOR A  
CHESAPEAKE BAY PLAN

	1 Year	2 Year	3 Year
Water Resources Element			
Hydrologic System			
Water Supply			
Water Pollution			
Waste Disposal			
Flood Control			
Other Natural Resources Element			
Fisheries Plan			
Wildlife Plan			
Wetlands Plan			
Resource Extraction Plan			
Shoreline Protection Element			
Natural Process			
Recreation and Open Space			
Shore Development			
Soil Conservation			
Bay-Related Element			
Marine Transportation			
Water-Related Industry			
Water-Related Power			
Waterfront Access			
Water Recreation			
Coordination and Implementation Element			
Intergovernmental Relations Plan			
Citizen Participation			
Legislative			
Financial			
Information System			
Planning and Research			
Economic Evaluation			
Plan Formulation (Preliminary Plan Preparation)			

addition, the Bay planning agency should exhibit three major traits: comprehensiveness, coordination and responsibility. Over-riding all criteria for institutional alternatives to guide Bay planning and management is the necessity to tailor decisions to the needs of citizens and elected officials and to the problems of Maryland and the Chesapeake Bay.

ALTERNATIVE ONE

**Continue the current CBIPC structure.** The CBIPC has been effective to a degree but has been hampered by lack of staff and by divergent views of what it should do. As a committee, it serves at the pleasure of the Governor whose attention must be focused to a large degree on day-to-day decisions. As a committee, CBIPC does not have the stature or institutional responsibility necessary for the major task of preparing a Bay plan. It has served as a forum for different ideas and views, but is not a decision-making group. If it made decisions, they would not be binding on constituent departments.

Although the CBIPC could be staffed adequately, partly from departments and partly with its own personnel, its "informal" status is a compelling reason for rejecting it as the body to prepare a Bay plan.

ALTERNATIVE TWO

**Reconstitute the CBIPC as a formal, temporary Commission, either by assignment from the Governor and concurring resolution by General Assembly, or by Act of the General Assembly.**

The latter is not necessary but is desirable to indicate legislative intent. In either event, the temporary Commission should be responsible to the Governor.

A temporary commission would best meet criteria for the planning process. It centralizes responsibility for preparation of the plan. Assuming adequate funding, this alternative recognizes the importance of the effort and would provide for a task force of staff and consultants to carry it out. Its work would be separate from day-to-day management planning but related to it.

A temporary commission would be accessible through public hearings. It could be assigned to coordinate Federal and local agencies within its area of concern.

ALTERNATIVE THREE

**Create a "Chesapeake Bay Commission" (CBC) through the Governor's sanction (executive order) and/or legislative mandate.** This group would comprise the Governor (or Lt. Governor) of Maryland as permanent commission chairman, with the Secretaries of State Planning, Natural Resources, Community and Economic Develop-

ment, Transportation, and Health and Mental Hygiene as commission members. The "Commission" should meet annually within one month prior to the Susquehanna River Basin Commission's annual summit meeting (attended by the Secretary of Interior and governors of the three signatory states as the four commissioners). Each CBC member should designate an alternate to represent the policies, programs and technical abilities of his agency. The par-

ent CBC might direct the alternate from the Department of State Planning to supply staff services to the Commission in addition to his other responsibility. The Alternates Commission should meet at least quarterly.

To insure that a broad spectrum of the citizenry is involved in Bay decision-making, committees would be created at the discretion of CBC. However, one permanent committee composed of vari-

ous members of the conservation-industry-scientific sector should be established to serve as an advisory council. While the specific scope of CBC responsibilities are not finite, generally, the "Commission" would serve as a forum for discussion of major issues affecting the Bay; would have mandatory advisory responsibilities on overall programs of Baywide significance, including legislative review and initiation; would offer a broad range of working policies, technical expertise and strategies for Bay management; and, would be responsible for developing a Bay strategy for long-range management similar to the Susquehanna and Potomac Commissions.

ALTERNATIVE FOUR

**Create a "Chesapeake Bay Commission" (CBC) through the Governor's sanction and legislative mandate.** The "Commission" would be the same as in Alternative Three, with the addition of two members appointed by the General Assembly. Alternates and generalized scope of responsibilities would be the same as in Alternative Three, with the added possibility of knitting the executive, legislative and citizen sectors to implement Baywide management.

ALTERNATIVE FIVE

**Create a "Chesapeake Bay Commission" (CBC) through the reassignment of the Chesapeake Bay planning group within the Department of Natural Resources.** The CBC would be composed of the members of the existing CBIPC with staff services provided by the Department of Natural Resources. Generally, the role of this Commission would be policy planning for comprehensive Bay management and it would have advisory responsibilities on land and water-related issues. The informal directive of this group would be a comprehensive policy plan to aid the Governor and legislators in prudent management of the Bay's resources. The land use element of the Bay Plan should conform with the Department of State Planning's statewide Land Use Plan.

THE TASK FORCE APPROACH

The task force approach differs from the plan review and coordination approach in that the CBC

Chart 3 ALTERNATIVE INSTITUTIONAL CONCEPTS FOR A "CHESAPEAKE BAY COMMISSION"

Alternative Institutions	Creation	Composition*	Characteristics
1 Continue current CBIPC group		Five Department Secretaries**	<ul style="list-style-type: none"> <li>Generates Ideas, Not Binding Decisions</li> <li>Monitor Planning</li> <li>No Independent Staff</li> </ul>
2 Reconstitute CBIPC as Temporary Commission	Legislative Mandate	Five Department Secretaries**	<ul style="list-style-type: none"> <li>Planning and Management Planning</li> <li>Independent Staff</li> <li>Regulatory Responsibilities (limited)</li> <li>Hold Public Hearings</li> <li>Report to Governor</li> </ul>
3 Create a Chesapeake Bay Commission	Executive Order and/or Legislative Mandate	Governor or Lt. Governor Five Department Secretaries**	<ul style="list-style-type: none"> <li>Discuss Major Issues</li> <li>Initiate and Review Legislation</li> <li>Establish Working Policies</li> <li>Provide Technical Expertise</li> <li>Utilize Department of State Planning Staff</li> <li>SUBMIT AN ANNUAL REPORT TO THE GOVERNOR ON THE "STATE OF THE BAY"</li> </ul>
4 Create a Chesapeake Bay Commission	Executive Order and/or Legislative Mandate	Governor or Lt. Governor Five Department Secretaries** Two Members of General Assembly	<ul style="list-style-type: none"> <li>Discuss Major Issues</li> <li>Initiate and Review Legislation</li> <li>Establish Working Policies</li> <li>Provide Technical Expertise</li> <li>Utilize Department of State Planning Staff</li> <li>SUBMIT AN ANNUAL REPORT TO THE GOVERNOR &amp; GENERAL ASSEMBLY ON THE "STATE OF THE BAY"</li> </ul>
5 Create a Chesapeake Bay Commission	Legislative Mandate	Five Department Secretaries**	<ul style="list-style-type: none"> <li>Prepare a Comprehensive Plan</li> <li>Discuss Major Issues</li> <li>Utilize Chesapeake Bay Planning Staff from the Department of Natural Resources</li> <li>REPORT TO GOVERNOR</li> </ul>

\* An Advisory Committee including conservation, science and industry is recommended for each alternative.

\*\* Secretaries of State Planning, Natural Resources, Community & Economic Development, Transportation, Health & Mental Hygiene





would have a substantial task force staff of technicians hired specifically, and borrowed from relevant agencies. In addition, major "assignments" could be undertaken by Department specialists as well as by consultants.

#### REPORT TO THE GOVERNOR

The CBC should, at the conclusion of the planning period, deliver to the Governor and the General Assembly the Preliminary Comprehensive Plan for the Chesapeake Bay. The Plan should be subjected to legislative debate and public hearings, and, as modified and as appropriate, approved in principle by resolution.

Whatever the organizational arrangements, the comprehensive plan for Bay resource management should be suitable for inclusion in the State Land Use Plan prepared by the State Planning Department to guide the economic and physical development of the State.

The CBC should make recommendations to the Governor regarding additional powers needed to implement the plan; the concurrence or non-concurrence of agency plans, including operating plans, with the Comprehensive Plan; suggested intergovernmental relationships; and the CBC's own permanent role and stature.

#### INTERSTATE OPPORTUNITIES

The State of Maryland has committed funds and manpower to plan for prudent management of the Chesapeake Bay. While knowledge about Maryland's portion of the Bay is extensive and further studies are underway, the Virginia part of the estuary cannot be ignored. Strong cooperative effort among states in the development of policies and programs is essential to avoid duplication and gaps. At present, Virginia and Maryland are working together to resolve a number of single purpose Bay-related problems. Likewise, Maryland and her sister states have entered into the Susquehanna River Basin Compact with the Federal government. However, no formal attempt has been made to address comprehensive management planning for the Bay.

Maryland must continue to work for a formal agreement for the Bay. Activities that rely on the economic, environmental and social resources of the Chesapeake Bay and the local, regional and national significance of the Bay justify this effort. In the absence of a formal agreement, Maryland should continue to coordinate its Bay planning efforts with Virginia and with Federal agencies to insure common purpose.

## **SPECIAL ACKNOWLEDGEMENTS**

Governor Marvin Mandel constituted the Chesapeake Bay Interagency Committee by executive order in 1969. Special acknowledgment is given to the following former members of the committee and principal staff participants for their valuable contribution during the initial stages of this study.

Joseph Stanton  
*Maryland Port Administration*

David Fisher  
*State Highway Administration*

William Pate  
*Division of Economic Development*

Joseph Manning  
*Department of Chesapeake Bay Affairs*

Paul McKee  
*Department of Water Resources*

Spencer Ellis  
*Department of Forests and Parks*

George Shield  
*Department of Game and Inland Fish*

Kenneth Weaver  
*Maryland Geological Survey*

Robert August  
*Department of State Planning*

All reference notes to tables in this report are identified in the *Maryland Chesapeake Bay Study*, prepared by Wallace McHarg Roberts and Todd, Inc.

The preparation of this Report, maps and documents were financed in part through a comprehensive planning grant from the Department of Housing and Urban Development, as administered by the Maryland Department of State Planning.

**Title:** Integrity of the Chesapeake Bay

**Author:** The document was condensed by the Maryland Department of State Planning, with assistance by Urban Research and Development Corporation, from the Maryland Chesapeake Bay Study prepared by Wallace, McHarg, Roberts and Todd, Inc.

**Subject:** Chesapeake Bay

**Date:** July 1972

**Planning Agency:** Maryland Department of State Planning

**Source of Copies:** Clearing House for Federal Scientific and Technical Information  
Washington, D. C.

Department of Housing & Urban Development  
Regional Office  
Baltimore, Maryland

Maryland Department of State Planning  
State Office Building  
Baltimore, Maryland

**HUD Project Number:** 92

**Series Number:** Not Applicable

**Number of Pages:** 52

**Abstract:** This document represents a summary of the major findings and conclusions contained in the "Maryland Chesapeake Bay Study", a report prepared for the Chesapeake Bay Interagency Planning Committee. The Bay Study represents the first comprehensive Maryland Chesapeake Bay inventory of natural resources and economic development problems with suggested mechanisms for management planning.

This Summary Report of the Bay Study is divided into three major sections. The first describes the general characteristics of the Chesapeake Bay including its physical and natural characteristics, its commercial value, economic viability, and the population within the Bay Region.

Eight major problems which have ecological, social, economic and planning and management significance to the Bay and goals useful in ameliorating the problems are discussed in the second major section of this report.

The final section outlines the elements needed to prepare an effective management plan for the Chesapeake Bay. Alternative management institutions which would respond most effectively to the Bay problems are also discussed.

PHOTOGRAPHS

Page 11	Maryland Department of Economic and Community Development
Pages 17, 40-41, 43, 44, 46	M. E. Warren
Page 19	Peter C. Chambliss
Pages 20-21, 31	Richard E. Keister, Maryland Department of State Planning
Pages 25, 29	B. L. Braun
Page 36	Tadder
Page 51	David Harp

**COASTAL ZONE  
INFORMATION CENTER**

